



# POWERRAIL

---

## AUSTRALIA

**Locomotive Products**

---

**CATALOGUE** V23

---

Parts, Components and Enhancements

**POWERRAIL**  
DISTRIBUTION  
Established  
2003

RRR M-1003  
CERTIFIED 

---

# MISSION STATEMENT

---

*It is the objective of PowerRail to provide Products and Services that meet our exemplary standards of Quality, Service, Delivery and Value, which consistently meet or exceed our customers' expectations.*



PowerRail Holdings, Inc., together with its affiliates, Vendors/Partners (collectively "PowerRail") offers a wide range of aftermarket replacement parts for EMD and GE brand locomotives.

PowerRail does not claim to be an authorized distributor nor does it claim to sell any Genuine OEM factory parts. PowerRail claims no proprietary rights to, or affiliation with, any third party trademarks or logos which may appear in any of PowerRail's marketing materials.

[WWW.ePowerRail.Com](http://WWW.ePowerRail.Com)

# 20<sup>th</sup> Anniversary

# POWERRAIL

CREATIVE INNOVATIONS...CONTINUING TRADITION  
Est. 2003



To Our Valued Customers:

When I first began this endeavor in 2003, I never stopped to dream about what kind of growth we could experience 20 years down the road. I was motivated and determined to show the rail industry a new option for purchasing locomotive parts and components. Now, as we celebrate our 20th anniversary, I reflect on the expansion and development that this company has undergone, and I am in awe.

I am eternally grateful to the employees of PowerRail. Their dedication to this company and commitment to our success is what makes all of this possible. I am sincerely appreciative of YOU, our customers. Thank you for trusting us and giving us the opportunity to service your locomotive parts needs.

I am excited to introduce to you our latest catalog, featuring PowerRail products, enhancements, and capabilities. We continue to expand our product offerings and create enhancements to better serve our customers. As always, we are dedicated to providing the Rail, Power Generation, Transit, and Marine industries with an alternate source for true M-1003 Quality parts and components, with competitive pricing and delivered in a timely manner.

We are pleased to extend our offering of "Enhanced Products," developed by our Engineering team and coupled with our M-1003 AAR Quality Program. These products symbolize our attention to customers' needs and the importance in providing better solutions to current applications and cost savings, all while keeping quality at the forefront.

We continue to expand our innovative series of remanufactured parts and components and our "New-UX<sup>®</sup>" program, which allows customers the opportunity to upgrade old cores for new product. Our programs offer true value and quality with unsurpassed flexibility and cost effectiveness.

In an effort to better meet the needs of our customers, we now offer an online Customer Portal. View our product offerings, place orders, track your shipments, pay invoices and much more.

To request access, please register at [WWW.ePowerRail.Com](http://WWW.ePowerRail.Com)

Thank you for the opportunity to serve your needs. Should you have any questions regarding our new catalog or our product line, please feel free to contact me or any member of the PowerRail team.

Sincerely,

*Paul P Foster*

Paul P. Foster  
CEO & Chairman of the Board



# TABLE OF CONTENTS

## Alphabetical Index

Description	Page	Description	Page	Description	Page	Description	Page	Description	Page
<a href="#">Air Brakes</a>	3	<a href="#">Cable 27 Pin MU</a>	15	<a href="#">Fuel Pump</a>	36	<a href="#">Insulation Testers</a>	59	<a href="#">Slack Adjusters</a>	96
<a href="#">Air Horns</a>	4	<a href="#">Camshafts and Crankshafts</a>	30	<a href="#">Fuses &amp; Hoses</a>	47	<a href="#">Journal Boxes - Hyatt &amp; GG</a>	60-61	<a href="#">Snow Plow</a>	70
<a href="#">Alternator</a>	4	<a href="#">Card Holders</a>	15	<a href="#">Gaskets</a>	48-50	<a href="#">Levers &amp; Hangers</a>	94	<a href="#">Spark Arrestor</a>	70
<a href="#">Axle Generator</a>	5	<a href="#">Center Plates &amp; Bowl Liners</a>	86	<a href="#">Gauges</a>	50	<a href="#">Load Boxes</a>	62	<a href="#">Starter Motors</a>	71
<a href="#">Ball Valves</a>	6	<a href="#">Compressors - Air &amp; Water</a>	22-23	<a href="#">Gears</a>	51	<a href="#">Mirrors</a>	14	<a href="#">Swing Hangers</a>	96
<a href="#">Batteries</a>	6	<a href="#">Chemicals &amp; Cleaning Products</a>	16-20	<a href="#">Gear Cases</a>	87-93	<a href="#">Modules</a>	25, 63	<a href="#">Switches</a>	72-74
<a href="#">Bearings</a>	7	<a href="#">Circuit Breaker</a>	21	<a href="#">Gear Cases Seals</a>	94	<a href="#">Name Plates</a>	63	<a href="#">Terminal Boards</a>	75
<a href="#">Brakes &amp; Bushings</a>	85	<a href="#">Coil &amp; Leaf Springs</a>	86	<a href="#">Generators</a>	52	<a href="#">Oil Filler Cap</a>	81	<a href="#">Terminal Lugs</a>	83
<a href="#">Brake Handles</a>	7	<a href="#">Control Stands</a>	24	<a href="#">Generator Drive Shaft</a>	53	<a href="#">Oil Pump</a>	37	<a href="#">Tools</a>	76
<a href="#">Brake - Handwheel</a>	7	<a href="#">Contactors &amp; Controllers</a>	25	<a href="#">Governors</a>	32	<a href="#">Pipe Clamp Brackets</a>	64	<a href="#">Top Deck Kits</a>	40
<a href="#">Brake Shoes</a>	8	<a href="#">Couplers, Yoke &amp; Draft Gears</a>	26	<a href="#">Handrails &amp; Supports</a>	97	<a href="#">Power Assemblies</a>	34-35	<a href="#">Traction Motors</a>	77-82
<a href="#">Brushes - Carbon</a>	9	<a href="#">Cylinder Test Valve</a>	30	<a href="#">Heat Exchanger</a>	55	<a href="#">Refrigerators</a>	14	<a href="#">Traction Motor Cables</a>	79
<a href="#">Brushholders</a>	9	<a href="#">Diodes</a>	27	<a href="#">Heat Shield</a>	54	<a href="#">Relays</a>	25	<a href="#">Traction Motor Covers</a>	80
<a href="#">Bogie Assemblies</a>	84	<a href="#">Engines</a>	28	<a href="#">Heaters</a>	54	<a href="#">Resistor Grids</a>	65	<a href="#">Treads</a>	68, 97
<a href="#">Bogie Kits</a>	95	<a href="#">Engine Parts</a>	29-39	<a href="#">Horn Covers</a>	4	<a href="#">Rocker Arms</a>	38	<a href="#">Turbocharger</a>	98
<a href="#">Bogie Parts</a>	85-96	<a href="#">Engine Fans &amp; Gears</a>	31	<a href="#">Hoses - Air</a>	56	<a href="#">Roots Blower</a>	39	<a href="#">U Tubes</a>	83
<a href="#">Bogie Parts Catalogue</a>	96	<a href="#">Engine Kits</a>	40	<a href="#">Hoses - Dummy</a>	57	<a href="#">Safety Line</a>	66-68	<a href="#">Valve Bridge</a>	38
<a href="#">Bumper Cab - Safety Head</a>	9	<a href="#">Engine Protectors</a>	35	<a href="#">Hoses - Engine</a>	57	<a href="#">Sand Nozzles</a>	65	<a href="#">Water Pump</a>	37
<a href="#">Bulbs</a>	10-11	<a href="#">Exhaust Products</a>	41-42	<a href="#">Hoses - Freight Car</a>	57	<a href="#">Seals</a>	48-50	<a href="#">Wheel Sets</a>	99
<a href="#">Cabinets - High Voltage</a>	12	<a href="#">Fasteners</a>	43	<a href="#">Hoses - Sand</a>	58	<a href="#">Seats</a>	69	<a href="#">Wiper Motors, Arms &amp; Blades</a>	100
<a href="#">Cab Doors &amp; Weather Stripping</a>	13	<a href="#">Filters - Air &amp; Fuel</a>	44-45	<a href="#">Housings</a>	58	<a href="#">Shims &amp; Spacers</a>	69		
<a href="#">Cab Flooring, Latches &amp; Locks</a>	14	<a href="#">Filter - Coalescing</a>	47	<a href="#">Injectors</a>	33	<a href="#">Shock Absorbers &amp; Snubbers</a>	70		
<a href="#">Cabs - Support Items</a>	14	<a href="#">Filter Kits</a>	46	<a href="#">Inspection Kits</a>	40	<a href="#">Signage</a>	63		



\*Be sure to look for our Enhanced Products throughout this catalogue. These are the products that have been enhanced for the sole purpose of offering our customers a better product with cost savings, reliability and quality in mind.



**AIR BRAKES**

Complete line of 26L Air Brakes - New and Unit Exchange



PowerRail P/N	Portion Mounting Gaskets
E8034030	H5 Relay Air Valve
E40060576	J-1 Relay Valve
E40017143	F-1 Selector Valve
E40005088	MU-2A Valve
E9567871	Quick Rel. Valve (26F)
W557924	Service Portion (26F)
E9563583	26C Brake Valve
W557237	26L Brake Valve
E9573051	P2A Appl. Brake Valve
E40005089	A-1 Charge. Cut-Off Valve
W554061	J-1.4-14 & J-1.6-16 Relay
W97368	J-1 Relay Valve
E9566234	KM2 Vent Valve
E6956120	DT3A Check Valve



**16185288 - 26L Air Brake**  
**\*UNIT EXCHANGE IN STOCK\***



Packing Cup Replacements

PowerRail P/N	Packing Cups
W524478	2" Packing Cup
W501863	3½" Packing Cup
W513750	5" Packing Cup
W501530	6" Packing Cup
W96556	8" Packing Cup
E8062832	9" Packing Cup
E8047865	10" Packing Cup
E8057546	11" Packing Cup
W99882	12" Packing Cup



Single Car Tester



W660999 - Angle Cock



3N1 Freight Valve

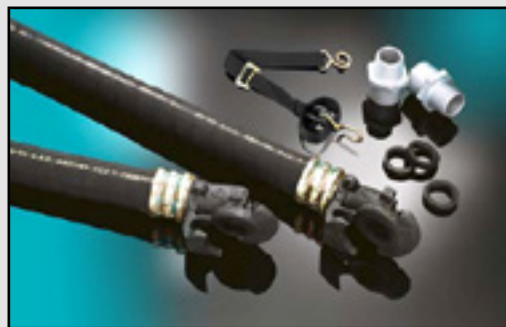

**Air Hose - See Page 56**



**Brake Shoes - See Page 8**

## AIR HORNS

Complete Line of Air Horns, Air Horn Covers and Related Parts



PowerRail P/N	Description
K1LAR	1 Chime
K3LR2	3 Chime Regular
K5LAR24	5 Chime Regular
WH-SA-110	Diaphragm Kit 3 Chime
WH-SA-112	Diaphragm Kit 5 Chime
E8185843	Rubber Mount for Roof



Cloth and Stainless Air Horn Covers provide protection from weather and elements

### 28 - 90 Volt DC Electronic Bell PowerRail Part# PRDEBELL82 with 30 Ft Harness



- Sound level: 85dB(A) at 50ft
- Adjustable Intensity & Loudness
- Weather Resistant Speaker
- 125 Rings per Minute
- Operating temperatures range from -40°F to 158°F

PowerRail P/N	Description
Cover Blue 4 3/4"	Cloth - Air Horn Bell
Cover Blue 6 1/4"	Cloth - Air Horn Bell
Cover Blue 8"	Cloth - Air Horn Bell
Cover Blue 9"	Cloth - Air Horn Bell
Cover Blue 11"	Cloth - Air Horn Bell
Cover Set K3SET	Cloth - Air Horn Set 3 Chime
Cover Set K5SET	Cloth - Air Horn Set 5 Chime
P36935	CDF Stainless 3 Chime
P36945	CDF Stainless 5 Chime

We also carry a full line of Horn Valves and other related parts.

## ALTERNATORS

Complete Line of Unit Exchange Main Alternators & Exciters

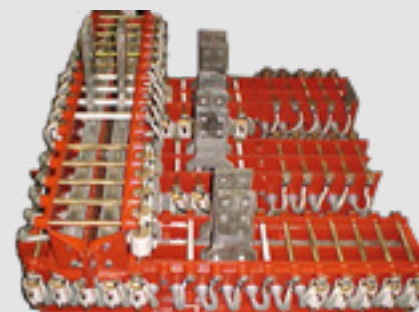

PowerRail Style	
AR10	TA17
AR11	AR20
AR15	GTA11
AR16	GTA24
AR17	

### Other Related Items

PowerRail P/N	Description	PowerRail P/N	Description
E40029131	Diode Negative	E8413188	Brushholder D14
E40029132	Diode Positive	E8413189	Brushholder TA17
E8378316	Diode Boot AR10	E8167423	Glass Oval AR10 6" x 12.13/16"
E8361524	Diode Socket	E8489788	Weather-stripping
E40032602	Diode Positive AR20	E8345780	Glass Inspection Air Box
E40032603	Diode Negative AR20	E8433679	Glass Diode Inspection
E40048214	Diode Boot AR20	E8167425	Weather-Stripping
E8434285	Spring Clip AR10	E8169637	Filler
E8434286	Spring Clip D14	E8330890	Brushholder Clip U Shape
E40132923	Spring Clip TA17	E8345866	Slip Ring Assly
E9084995	Rectifier Bank 2000V	E8390572	AR10 Closure



**AXLE GENERATORS & SENSORS, SPEED & TEMPERATURE**

Complete Line of Axle Alternators, Transducers and Sensors



<b>PowerRail P/N</b>	<b>Description</b>
E9319132	Axle Alternator
E40063597	Sensor SD70
E40121230	Sensor Speed SD70
E40021658	Sensor Temperature
E40029233	Sensor Temperature
E40134844	Sensor Temperature
E40063567	Sensor Oil
E40081692	Sensor Radar K Band
G17MM24F1	Axle Alternator
G17MM24AF1	Axle Alternator
G17MM102F3	Traction Sensor
G17MM57H401	Speed Sensor
G17MM103	Traction Sensor
G41A296328AAP	Sensor Temperature
E40026403	Axle Generator
E40039172	Axle Generator Kit
Q1164	60 Pulse Axle Generator
PQ93262	Q-Tron 120 PPR Axle Generator



PowerRail proudly offers a line of New and UX  
**17MM24AF Series Axle Alternators.**

In addition, we carry a full line of replacement Spades  
and Complete Shaft & Coupling Assemblies.

<b>Shaft w/ Coupling Part #</b>	<b>Length</b>	<b>Spade Part #</b>	<b>Coupling Part #</b>
G41B550222G3	4 1/16"	G492A173G4	G41A250225P1
G41B550222G1	4 7/16"	G492A173G2	G41A250225P1
G41B550222G4	4 3/4"	G492A173G5	G41A250225P1
G41B550222G8	7 17/32"	G41A251988G3	G41A250225P1
G41B550222G2	6 1/4"	G492A173G3	G41A250225P1
G41B550222G11	6 3/4"	G41A257468G1	G41A250225P1
G41B550222G5	7 3/16"	G492A173G6	G41A250225P1
G41B550222G7	10 3/8"	G41A251988G2	G41A250225P1
G41B550222G6	9 1/16"	G41A251988G1	G41A250225P1
G41B550222G10	5 3/16"	G41A251988G5	G41A250225P1
G41B550222G9	10 13/32"	G41A251988G4	G41A250225P1

## AIR BRAKE - BALL VALVES

Air Brake Ball Valves



- Teflon Seats
- Chrome Plated Balls
- Stainless Springs
- Zinc Plated Handles
- Self Tapped Bodies

PowerRail P/N	Pipe Size	Porting	Vent	Position:		Plain/Locking	Handle Length
				Open	Closed		
E8454218	3/4"	Standard	7/32" B	90°	0°	Plain	1 3/4"
E8452907	3/8"	Full	5/64" B	0°	0°	Plain	3 3/4"
E8363508	1 1/4"	Full	-	180°	90°	Locking	7 1/4"
E8458815	1 1/2"	Standard	-	0°	270°	Wrench	-
E8354227	1 1/4"	Standard	-	0°	90°	Plain	4"
E8409024	1 1/2"	Standard	-	0°	90°	Locking	5 1/8"
E8351610	1/2"	Full	-	90°	0°	Locking	3 1/8"
E8419531	1/2"	Full	3/32" B	90°	0°	Locking	3 1/8"
E8363655	3/4"	Full	-	90°	0°	Locking	3 1/8"
E8351609	1"	Full	-	90°	0°	Locking	5 1/8"
E9332599	1 1/4"	Full	1/8" B	90°	0°	Locking	5 1/8"
E8412325	1"	Full	1/8" B-NPT	90°	0°	Locking	5 1/8"
E8423393	3/4"	Standard	1/4" B-NPT	90°	0°	Locking	3 1/8"
E8467908	3/4"	Full	3/32" B	90°	0°	Locking	3 1/8"
E8451783	1"	Full	1/8" B	0°	90°	Locking	5 1/8"
E8365217	1 1/4"	Full	-	270°	0°	Plain	5 13/16"
E8351608	3/8"	Full	-	90°	0°	Plain	1 1/2"
E8463756	1 1/2"	Standard	-	0°	90°	Plain	4"
E10538664	3/8"	Full	-	0°	90°	Locking Sealed	3 1/8"
E9569220	3/4"	Full	-	90°	0°	Plain	4 7/16"
E8365777	1/2"	Standard	-	0°	90°	Plain	3 3/4"
E40014305	1 1/4"	Full	-	90°	0°	Locking	5 1/8"



### 8 Volt 4 Cell Series

PowerRail P/N	20 HR	8 HR	Length	Width	Height	Wgt.
P8HHG31PR	344	282	27	8	11 7/8	167
P8EHG31PR	410	336	27	8	12 3/4	178
P8NS23PR	430	352	28 1/4	8 1/4	18 1/4	242
P8CH23PR	582	477	28 1/4	8 1/4	18 1/4	256
P8NS33PR	625	512	28 1/4	11 1/4	18 1/4	352
P8CH33PR	846	694	28 1/4	11 1/4	18 1/4	414

### 32 Volt 16 Cell Series Unitized Series

PowerRail P/N	20 HR	8 HR	Length	Width	Height	Wgt.
P16CH25PR	635	521	33 3/8	27	20 1/2	1238
P16CH33PR	846	694	43	27	20	1609

### Acid Battery Water Level Indicator

PowerRail offer a simple solution for viewing water levels in Acid Storage Batteries. Our part # PRD16186371 utilizes a float with Min/Max lines for easy visual inspection.



## BATTERIES

Complete Line of Locomotive Switcher and Road Batteries



3 Year Warranty  
36 Lbs 8.5x10

### QuickCharge Model 64V/25A

115V or 230V Battery Charger  
LCD Display Amps & Volts  
Set Internal Switch for AGM,  
Deep Cell, Gels & Starting Batteries

### Built in SAFETY Feature:

Cables NOT live until  
connected to battery

### QuickCharge Battery Chargers

QP6425 64V/25A 117V 60HZ  
QP3225 32V/25A 117V 60HZ



### Other Related Parts

E8197509 Terminal Lug Battery  
E8211044 Terminal Lug Battery  
E40015058 Bolt Kit  
JUMPERRR31 Cable Jumper Kit

### Fiberglass Battery Box Grating

PRD16184575 - 1" Fiberglass Sheet  
PRD16184576 - 1 1/2" Fiberglass Sheet

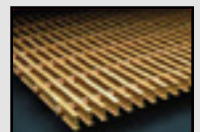



### BEARINGS

Complete Line of Engine Bearings

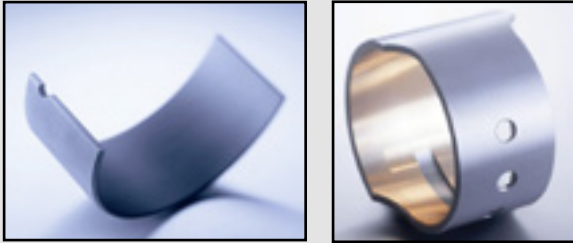

PowerRail P/N	Description
E8028006	Thrust Bearing Collar
E8028419	Thrust Bearing Collar
E8029461	Bushing
E8029491	Oil Pump Bushing
E8068624	Floating Bushing
E8071176	Cam Bearing
E8136114	Con Rod Bearing Lower
E8237900	Bearing Front Bracket
E8253825	Bearing Rear Bracket
E8341192	Insert Roots Blown
E8354118	Con Rod Bearing Upper
E8361565	Insert Carrier
E8452186	16 Cylinder Upper Main Kit
E8452210	16 Cylinder Lower Main Kit
E8455081	12 Cylinder Upper Main Kit
E8455083	12 Cylinder Lower Main Kit
E8455665	Rear Lower Main
E8455666	Front & Int. Lower Main
E8455667	Center Lower Main
E8455668	Center Lower Main
E8455844	Rear Upper Main
E8455850	Center Upper Main
E8455856	Center Upper Main
E8455862	Front & Int. Upper Main
E9571921	Rocker Arm Bushing
G114X1150	Lower Grooveless
G114X1103-1	Upper Grooved Main
G114X1111-4	Thrust Washer
G114X1127-3	Thrust Washer
G116X1184EFI	Large Cam
G117X1028-2	Articulated Rod
G117X1045-2	Upper & Lower Con Rod
G117X1050-1	Grooveless Con Rod
G117X1070	Upper Grooveless Con Rod
G117X1075	Lower Grooveless Con Rod
G142X1019	Standard Piston Pin Bushing
G142X1042	Piston Pin Bush .30 oversize

### BRAKE HANDLES

Complete Line of Brake & Reverser Handles.  
Manufactured in Steel, Bronze and New Safety Plastic



**Safety Handles - Color Coded and Glow in the Dark!**

PowerRail P/N	Description
E8251349SAFETY	Independent Brake
E10563802SAFETY	Reverser Handle Safety
E8269348	Independent Brake - Offset
E8495188	Independent Brake - Offset
E9550359BLK	26C Automatic Plastic Safety Version
E9550359	26C Automatic Steel Construction
G84B512767P1	Reverser Handle
G41B557247G1	Reverser Handle

### BRAKES - HANDWHEEL & RATCHET

Complete Line of Wheel and  
Ratchet Style Handbrakes





\*O.A. — Overall Chain Length  
\*B.H. LF — Chain Length Below Hand Lever Fulcrum



PowerRail P/N	Model	Dia	Chain Length *O.A.	*B.H. LF	End Link
E6948643	850-7	22"	6'-5"	5'-11"	18
E6946788	850-7	22"	14'-4"	13'-10"	1091-A
E6938301	850-7	16"	14'-0"	13'-6"	1091-A
E6948643	850-B	18"	6'-5"	5'-11"	1091-A
E6949785	850-C	22"	14'-10"	14'-4"	1091-A
E6942139	850-7	22"	15'-8"	15'-2"	1091-A
E6939749	850-7	20"	15'-8"	15'-2"	1091-A
E6955210	850-C	22"	6'-5"	5'-11"	1091-A
E6949199	850-B	18"	6'-5"	5'-11"	1091-A
E6953126	850-C	18"	15'-4"	14'-10"	1091-A
E9093520	850-7	22"	11'-6"	11'-0"	1091-A
E9097828	850-7	18"	11'-6"	11'-0"	1091-A
E9501206	850-7	20"	11'-1"	10'-7"	1091-A
E9322184	850-7	20"	13'-0"	12'-6"	1091-A
E9507177	850-7	20"	10'-11"	10'-5"	1091-A
E40019843	850-B	22"	6'-5"	5'-11"	1091-A
E10576362	850-B	22"	35'-4"	34'-10"	1091-A
E6969970	850-B	22"	33'-4"	32'-10"	1091-A
E40037149	850-1	22"	6'-6"	7'-0"	18

### BRAKE SHOES

Complete line of 26L Air Brake - New and Unit Exchange

Locomotive Brake Shoes	Shoe Length	Shoe Face Width	Face Design	Side Relief	Tie Plate	Taper	Rejection Lugs	RFP Alternative
<b>H33</b> 	14"	3"	Center Relief	Yes	Yes	No	High Friction Only	V330 V392
<b>H43</b> 	14"	3"	Full Face	Yes	No	45 End 5 Face	High Friction Only	N/A
<b>H63</b> 	18"	3"	Center Relief	Yes	No	No	High Friction Only	V188 V381
<b>L35</b> 	14"	3"	Center Relief	Yes	No	No	Low Friction Only	V553 V381
<b>L63</b> 	18"	3"	Center Relief	Yes	Yes	No	Low Friction Only	V555 V556 V575

**We offer a complete line of both High and Low Friction**

**BRUSHES - CARBON**

Complete Line of Premium Carbon Brushes: Traction Motor, Main Alternator and Generator, Blowers, Heaters, and Fans



PowerRail P/N	Application
E40034666	AR10
E6727520	Aux. Gen.
E9096661	Aux. Gen.
E9096992	Aux. Gen.
E8271326	Aux. Gen. Grid Blower
E4996232	Aux. Gen.
G998X67 G998X90	Fuel Pump
G149X1011-1 G149X1051	Fuel Pump
G2X4460	Heater
G6727520P1	Aux. Gen.
G41A239329P2	GTA11 Alternator for Steel Ring
G221F223P1 G221F234P1	Fuel Pump
E8307806	D12-D25 Main Gen.
E8413190	D14/D16 Main Gen.
E8330994 - Old E8417868 - New	D32 Main Gen.
E9322054 2 Wafer	D27-D57 TM
E9322058 3 Wafer	D77-D78 TM
E40070976 5/8 x 2	w/ Insulation
E40047198 3/4 x 1 1/2	D87 24/TM, D87 16/TM
E8078488	Fuel Pump
E9569980	Cab Heaters
E1906989	Starter
G41A330412P2	Alternator
G41B537963P1	752E8 TM
G41B535803P3	752AF & AG TM
G149X1051-1	Cab Heater Motor

**\*Many Others Available**

Please call us for our complete listing  
We also offer a Full Line of Springs & Studs



**BRUSHHOLDERS**

Complete Line of New and Unit Exchange Brushholders



PowerRail P/N	Holder Application	Brush Size
E8084210	D12 D22 Main Generator	5/8 x 1 1/16
E8124419	D15 D25 Main Generator	5/8 x 1 5/16
E8331071	D14 D32 Main Generator	.842 x 1 5/16
E8338116	Spring Cell Brush Holder	
E8413188	D14 Alternator	3/8 x 3/4
E8413189	AR10/TA17 Slip Ring	1/2 x 1 1/4
E5551980	A7159 Auxiliary	1 X 5/8
E5387140	A7159 Auxiliary	5/8 x 1 3/4
E8174433	D29 Traction	5/8 x 1 3/4
E8290124	D31 Traction	5/8 x 1 3/4
E8417729	D57/D77/D78/D87 Traction Motor 16/Mtr	5/8 x 2
E9550251	D87B Traction 24/Mtr	.713 x 1 1/2

PowerRail P/N	Holder Application	Brush Size
G41B530658G1	GY19/GY27/GY50 Main Generators	1/2 X 1
G6733792G1	GT566/568/581/586/603 Main Generators	3/4 X 1 1/4
G334B746 G6732876	GT558 Main Generator	5/8 X 1 1/4
G41B531649 G41C633095	GTA22/24/25/26 Main Generator	3/4 X 1 3/4
G41B537170G1	GMG185A Alternator	3/4 X 1 3/4
G41C632667G1 G41C632667G6	GE752 Radial Traction Motor	3/4 X 2 1/4
G41C633771G1 G41C633771G3	GE752 Reaction Traction Motor	3/4 X 2 1/4

**BUMPERS CAB - SAFETY HEAD**

Complete Line of Cab Safety Bumper Protection

E10568293	13 1/4" L
E10596355	23" L
E10615556	Left side 8"
E10615560	8" L
E10643171	17" L
E10643172	8 1/4" L
E10643173	15 1/4 L
E10643249	18" L
E10666194	17 L
E40047167	8" L

E40050919	14 1/4" L
E40072060	16.56" L
E40072097	11" L
E40100014	22.154" L
E40100015	18" L
E40126589	14" L
E40141486	4" L
E9312229	18" L
E9321670	20 3/4" L

\*Partial Listing of  
Common Bumpers



**BULBS**

Complete Line of Premium Grade Light Bulbs:  
Incandescent, Halogen, and LED



**PRD16184541 6-Button Switch**

Designed to meet the vibration and electrical requirements of locomotives that utilize electronic/computer enhanced switches.



- Solid state 1 Million click reliability
- Exact Terminals
- Exact Drop In
- Sealed Unit
- Custom Silk Screen Button Labels

**E8287294LED New LED Dimmable Bulbs for Control Stands**

- Flat or Domed
- Long Life LED Light - Lasting Up To 100,000 Hours
- Multiple Colors Available: Amber, Blue, Green, Red, and White
- Designed For Durability with Polycarbonate Lens



**Cab Ceiling Lights Single or Dual Lamp**

PowerRail Part #:  
E9096838 - Single Lamp  
E9502221PRD - Dual Lamp  
Enhanced Design with One or Both Bulbs On/Off Option

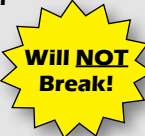

**Polycarbonate Globe Light Fixture**

- Polycarbonate Material
- **WILL NOT SHATTER** (like glass)
- High Heat Applications



8004613PRD

**Safety Lights**

PRD16187089 Step Light



G41A205337ABP2  
LED Walkway Lights

PowerRail P/N	Description	Style
 E8140357	2 Watt/6V	Incandescent
E8140357LED	2 Watt/6V	LED
 GE1828	1.8 Watt/37.5V	Incandescent
GE1828LED-RED GE1828LED-WHITE	1.8 Watt/37.5V	LED
 GE1866	.25 Watt/6.3V	Incandescent
GE1866LED	.25 Watt/6.3V	LED
 50A19	50 Watt/75V Rough Service	Incandescent
16201 50W Premium	50 Watt/75V Rough Service	Incandescent
 RS50A19LED-6WLL	6 Watt/75V Rough Service AAR S-5515 Compliant IP67	LED Totally Sealed
 RS50A19LED-6W-SL1	6 Watt/75V Rough Service IP65 - Universal Application	LED
 16187555	6 Watt/75V Rough Service IP65	LED
 30S11	30 Watt/75V	Incandescent
 SLS30S11LED-12CL1	30 Watt/75V	LED
 200PAR56	200 Watt/32V Headlight	Incandescent 200 Watt
 200PAR56FRA	250 Watt/32V Headlight FRA Approved	Halogen 250 Watt
 350PAR56	300 Watt/75V Ditch Light	Incandescent 350 Watt
 350PAR56FRADUAL	400 Watt/75V Ditch Light FRA Approved	Halogen 400 Watt
 LED350PAR56	75Volt Head/ Ditch Light IP67	LED

**BULBS**

LEDs for Freight and Passenger Locomotives and Cars

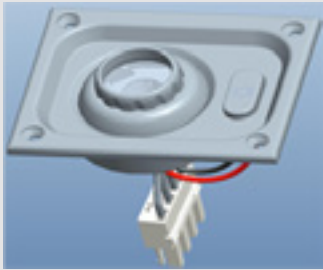

LED Circuit Board Technology for Reading Lights, Specialty Lights, and Upgrading from Incandescent to LED

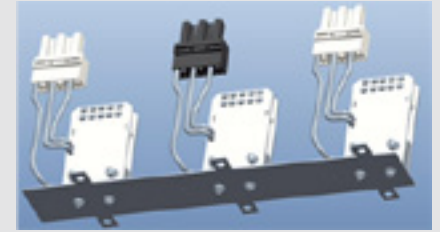

**T8 LED Tube**

- provides optimum light distribution for interior spaces
- V-shaped mount and rotatable end-cap provides homogeneous light distribution
- provides 50,000 hr life cycle to reduce maintenance costs
- 22W energy consumption per 4-foot length
- available in 3 color temps - warm, neutral or cool white



PowerRail P/N	Operating Voltage	Power	Length	lpw	
				Clear	Frost
SLS-T8V-G60-24V-10W-__-__	24V DC	10W	588mm	120 lpw	110 lpw
SLS-T8V-G120-24V-22W-__-__	24V DC	22W	1,198mm	120 lpw	110 lpw
SLS-T8V-G150-24V-28W-__-__	24V DC	28W	1,498mm	120 lpw	110 lpw
SLS-T8V-G60-240V-10W-__-__	240V AC	10W	588mm	120 lpw	110 lpw
SLS-T8V-G120-240V-22W-__-__	240V AC	22W	1,198mm	120 lpw	110 lpw
SLS-T8V-G120-240V-28W-__-__	240V AC	28W	1,498mm	120 lpw	110 lpw



**Emergency Backup Power T8 LED Tube**  
Part #: SLS-UNV-EMB



- integrated battery backup power for emergency use
- designed to replace all external backup power ballasts and drivers to keep lighting ON in the event that the main voltage is off
- can be used for Facilities, Passenger Transit LRV, Locomotives and Cars
- incorporates test buttons to ensure battery is operational for Maintenance Personnel or Fire Marshal certification
- can be suited to operate on various voltages

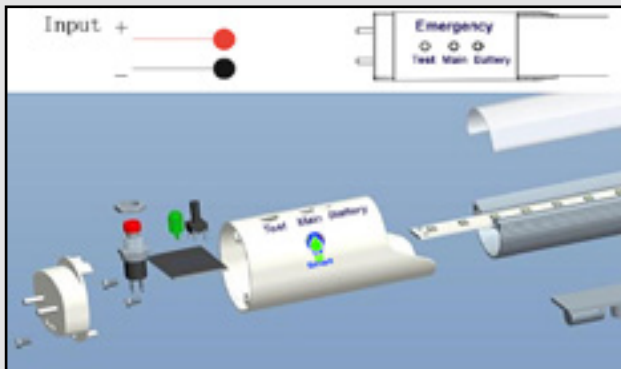

**75V DC LED Work Lights**  
Part #: 16186821

Powered by the MU Outlet on the locomotive car body (or optional knife switch connector), these lights provide proper and safe lighting for your work crew when repairs are necessary in the field.

**Features**

- Twin LED 18Watt Lights
- OEM Style Light Housings
- Tiltable Magnetic Base with Safety Handle
- MU Connection for Power (Knife Switch optional)
- (2) 50' Power cord UL Listed Expandable
- Safety Locking Connectors UL Listed
- Made in USA



### **CABINETS - HIGH VOLTAGE**

PowerRail proudly offers a complete line of New and Refurbished High Voltage Cabinets.



PowerRail’s team of electricians has over 30 years of locomotive electrical experience.

Scope of work for refurbished High Voltage Cabinets includes stripping, cleaning, welding as required, painting, and assembling with breakers, resistors, capacitors, terminal lugs, wire and cable runs, as well as rebuilt contactors, switchgear, etc. to Customer’s specifications.



## CABS

Complete Line of Regular & New Crashworthiness Cabs, Frames and Fuel Tanks

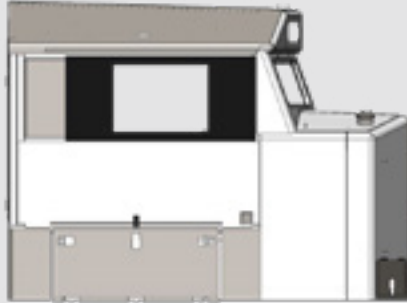
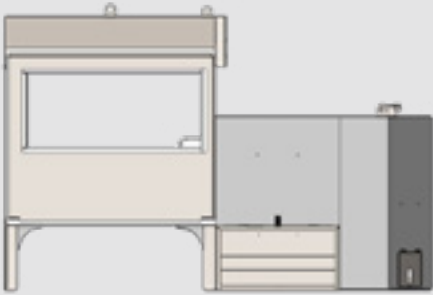

New Frames



Cab with All Components



Cab Door Assemblies



Fuel Tanks - Standard & New Crashworthiness

## CAB DOORS

Complete Line of Cab Doors and Windows

Made of Aluminum that Will Not Rust!

Complete with Oversized Frame and Lock and  
Wiper Holes already Pre-Drilled!

PowerRail P/N	Description
E8461881PRD	Alum. Door with Frame Only
E9526353	Glass for Door and Windshield
E8284665	Lock Assembly Keyed
E8465525	Lock Assembly Non Keyed
PRD17164	Slide Lock
E9528757	Window Side 16 x 26 1/4



E8167296  
Flame Arrestor Fuel Tank

## CAB DOOR - WEATHER STRIPPING

Complete Line of Weather-Stripping and  
Enhanced Weather-Stripping Seals

PowerRail P/N	Description
E40014788	SD70 Rear Cab Window and Cab Windshield 15'
E8329872	Weatherstripping 7' 4" long
E8286959	Weatherstripping Sponge Rubber 5/32" x 1/2" x 50'
E8419908	Number Board Weatherstripping 80", 1/8" Groove
E9544282	Hinge Guard Weatherstripping 58 7/8"
E6979365	SD60, 70, 80 Cab Door Overlap 74 7/16 x 21 7/16
E8489788	Hood & Sanding Door 10 Ft. Lg 1/8" x 1/4" Groove
E9544282	Hinge Door Guard 58 7/8" Long



E8048140  
4 x 4 Hinge

E9334250  
Awning Window



### CAB FLOORING

Complete line of Locomotive Cab Flooring provides slip-resistance and durability. Lightweight aluminum 4' X 8' panels coated with a proprietary blend of minerals and an abrasive epoxy grit. Provides strength, durability, and safety.

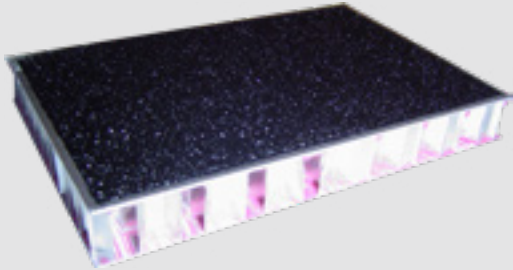

### CAB SUPPORT ITEMS

Complete Line of Cab Support Items including Refrigerators, Fans and Coat Hooks

PowerRail P/N	Description
ME4130 1.5 in <sup>3</sup> ME4170 2.5 in <sup>3</sup>	Refrigerator - 110V w/ Built-in Inverter
ME804	Cab Fan 74 VDC - Single or Dual Speed
PMC945G	1000W 3 Switch 10" Dia.
E9509437	Cup Handset Hangup
E8145407	Coat Hook
E9550240	Sun Visor - Ball Mounted
E9331382	Sun Visor - Straight Mount
E40006334	Sun Visor - Straight Mount
E8370302	Mirror with Bottom Deflector
SC875-32	Mirror - Right or Left Mount
E9573201	Mirror - Engineer 5 x 8" Left Hand
E9573200	Mirror - Engineer 5 x 8" Right Hand
PM118-5	Toilet Stainless Steel



### CARBODY DOORS

Complete Line of Enhanced **Fiberglass** Doors. Doors are Fiberglass in lieu of steel. Will not rust and reduced weight minimizes injuries related to these products.

***MORE than 60% Lighter than Steel Doors!***



PowerRail P/N	Description	Length	Application
E9555859	Battery Door	52"	GP/SD Styles - Eng'r & Helper
E9321887	Air Brake Door	63"	GP/SD Styles - Helper Side
E9321884	Air Brake Door	75 1/2"	GP/SD Styles - Eng'r Side
E10584100	Cab Fresh Air	28 3/4"	SD Styles - Helper Side
E10584138	HVAC Door	64 7/8"	SD Styles - Helper Side
E40034382	Battery	48 3/4"	SD Styles - Helper Side
E10576735	Air Brake	64 7/8"	SD Styles - Eng'r Side
E40019273	Air Brake	28 3/4"	SD Styles - Eng'r Side
E40121076	Battery	27"	SD Styles - Eng'r Side
E10666450	Air Brake	29 1/4"	SD Styles - Eng'r Side
E10666451	HVAC w/ Vents	29 1/4"	SD Styles - Eng'r Side

### DOOR - LATCHES & LOCKS



#### E8158536PRD Door Latch Assembly

- Improved Lever Design for Smooth Operation
- Advanced Painting Method for Extended Life
- Passenger & Class 1 Approved

#### E8278056 Slide Lock

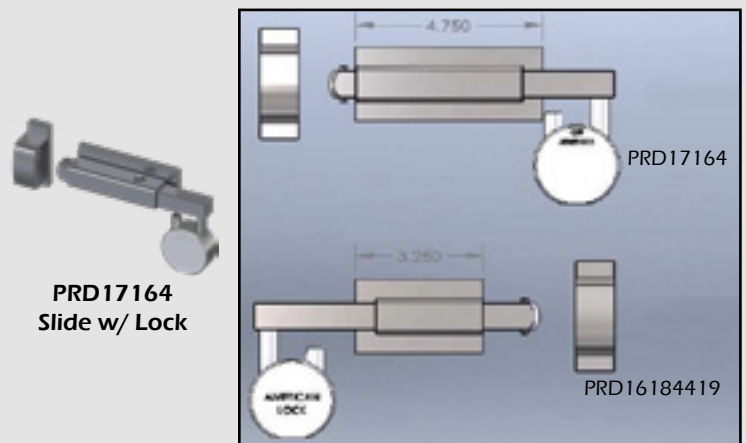

#### PRD17164 Slide w/ Lock



## CABLE 27 PIN MU - RECEPTACLES & HANGERS

Complete Line of Premium MU Cables & Hangers

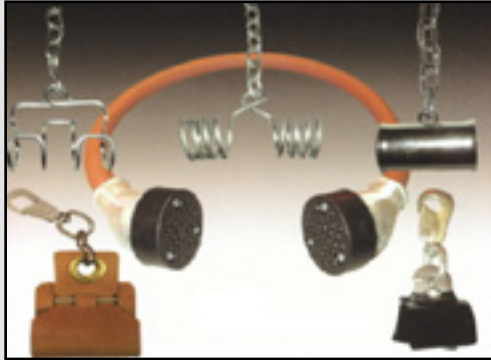









PowerRail P/N	Overall Length	Type
E8195546	5 Ft.	MU Cable
E8208511	7½ Ft.	MU Cable
E8195547	8 Ft.	MU Cable
E8195548	9 Ft.	MU Cable
E8196711	11 Ft.	MU Cable
E8200922	Hanger 2 Piece Split w/ Hook	
E9573822PRD	Hanger w/ Hook Enhanced Long Life	
HR-50	Hanger Solid/Fixed	
PP16540	MU Wire Holder - Class 1 Style	

Note: Hangers add prefix C with Hook & Chain



## CARD HOLDERS

Complete Line of Card Holders

PowerRail P/N	Description	Comment
 C90260	4 Slot	Holds Qty 4 6" x 9" Cards
 C90227	Single Slot	11 ½ x 13 ½" Single Card 6 Holt Mount
 C90262	Single Slot	3 ½" x 4" 4 Hole Mount
 C10909	Vertical	Single Slot 9" x 11" 3 Hole Mount
 G84B100710P1	Horizontal	Single Slot 9" x 11" 3 Hole Mount
 PP17672	8 Slot	8 Slot 4 hole 12 ½" x 19 ¾"
 PP12208	Single Slot	8" x 11 ½"
 G84B109851	Single Slot	9" x 11"
 G84B102294	3 Slot	10 ½" x 12 ½" 4 hole

\*Many others available on request.



**CHEMICAL LINE**

A complete line of biodegradable chemicals for the rail industry



PowerRail is dedicated to providing alternate solutions to the rail industry at competitive pricing. Our full line of ECO-FRIENDLY railroad chemistries are engineered exclusively for the production, cleaning, and maintenance of locomotives. We are proactive in providing products that eliminate hazardous waste and the subsequent environmental effects.



**299 - WATER LEAK**

Concentrated vivid tracing dye for use in detecting water leaks in water-cooled engines. Provides a vivid visual marker to trace and see the location of water leaks in normal lighting. Visibility is enhanced using a black light.

PowerRail P/N	Size	Comment
299TRACER-1	16 oz	Liquid - 12 Per Case



**288 FUEL LEAK**

Concentrated vivid tracing dye for use in detecting fuel leaks in diesel engines. Provides a vivid visual marker to trace and see the location of water leaks in normal lighting. Visibility is enhanced using a black light.

PowerRail P/N	Size	Comment
288-16-4	16 oz	Liquid - 4 Per Case
288-2-15	2 oz	Liquid - 15 Per Case
288-2-96	2 oz	Liquid - 96 Per Case

**HEAT EXCHANGER INHIBITOR**

Multi-metal safe corrosion inhibitor for use in locomotive diesel engine cooling systems to protect against premature failure due to corrosion. Inhibits corrosion of all metals including cast iron, steel, copper, brass, and solder.

**810** - Packaged in convenient, safety-oriented sticks

PowerRail P/N	Size	Comment
810WATER-BX	15 lb	Stick 15 lbs per Box



**850** - Packaged in convenient, safety-oriented liquid format. **NO MEASURING - Pour Directly Into Radiator**

PowerRail P/N	Size	Comment
850COR-5	5 Gallon	Liquid
850COR-55	55 Gallon	Liquid
805COR-275	275 Gallon	Liquid



**RADIANCE WITH TRACER** - Contains a concentrated vivid tracer dye for use in detecting water leaks in water-cooled locomotive engines.

PowerRail P/N	Size	Comment
Radiance-5	5 Gallon	Liquid
RADIANCE-55	55 Gallon	Liquid



**CHEMICAL LINE (con't)**



**RUST INHIBITORS**



PowerRail P/N	Size	Comment
PRD571RUST-5	5 Gallon	Liquid
PRD571RUST-55	55 Gallon	Liquid
PRD577RUST-5	5 Gallon	Liquid
PRD577RUST-55	55 Gallon	Liquid

**571 OR 577**

- Highly concentrated liquid inorganic rust inhibitor engineered for indoor storage of all iron and steel metal parts when additional corrosion, oxidation or rust protection is needed.\*
- Specifically designed to provide in-process rust protection of parts and for short-term part storage.
- Provides superior rust protection in wash and final rinse sections of all aqueous industrial parts washers, from heated high-pressure spray cabinet and conveyORIZED systems, to free standing manual and immersion-type tanks.
- Compatible with most alkaline compounds when simultaneously used.
- Harmless to engines and equipment.

\* 571 model is also safe for use on yellow and soft metals, in addition to iron and steel

**LOCOMOTIVE EXTERIOR AND FACILITY WASH**

**BREAK**



Ready-to-use, multipurpose, heavy-duty liquid detergent for cleaning all hard surfaces. Specifically formulated to clean oily residue and sooty grime found in factories, bathrooms, vehicles and offices. Virtually safe on all hard surfaces including: machinery, painted surfaces, wallpaper, counters, desks, and industrial fixtures. Contains no phosphates, is non-flammable, biodegradable and environmentally friendly.

PowerRail P/N	Size	Comment
BREAK-32	32 oz	Spray Bottle
BREAK-5	5 Gallon	Liquid

**TOTAL**



A heavy duty, aluminum safe, high pH, multipurpose degreaser and detergent capable of cleaning and degreasing everything from hard-surface concrete shop floors & walls, to industrial equipment, to company vehicles. Safe to use anywhere water is tolerable!

PowerRail P/N	Size	Comment
TOTAL-5	5 Gallon	Liquid
TOTAL-55	55 Gallon	Liquid

**TOTAL B**



A super duty, aluminum safe, high pH, alkaline degreaser and detergent engineered to attack the toughest grease, grime, soil or any other unwanted contaminants associated with facility maintenance cleaning. A multipurpose degreaser and cleaner that is aluminum safe and biodegradable. Safe to use anywhere water is tolerable!

PowerRail P/N	Size	Comment
TOTALB-5	5 Gallon	Liquid
TOTALB-55	55 Gallon	Liquid



## CHEMICAL LINE (con't)



### PARTS WASHER

PowerRail P/N	Size	Comment
CH14EX-50	50 lb	Pail
CH14EX-450	450 lb	Pail
14EXCAL-50	50 lb	Pail
14EXCAL-450	450 lb	Pail
SPRAYDETEL-5	5 Gallon	Liquid
SPRAYDETEL-55	55 Gallon	Liquid

#### **CH14EX**

A highly concentrated, multi-metal safe, alkaline powdered detergent engineered to produce superior cleaning results for aqueous process parts cleaning.

#### **14EX CALIBER**

A highly concentrated, multi-metal safe, alkaline powdered detergent engineered to produce superior cleaning results for aqueous process parts cleaning; specifically baked on carbon deposits and carbonaceous oil, grease, and grime.

#### **SPRAYDET EL**

A highly concentrated, multi-metal safe, alkaline liquid detergent engineered to produce superior cleaning results for aqueous process.



CH14EX DRUM

**NOTE:** All options above perform in all aqueous industrial parts washers including heated high-pressure spray cabinets, conveyor style spray wash systems, freestanding manual and immersion type tanks, and more!

#### **AQUA SOLV II**

Aluminum safe, non-hazardous, liquid detergent engineered to be specifically used in manual types of fountain style aqueous parts washers or “Sink on a Drum” type units to produce superior cleaning results for the removal of the toughest contaminants. Contains specialty surfactants for excellent carbon, grease, and grime removal. Non-VOC by CARB definition per ASTM D1298.

#### **SPRAYDET RS**

A highly alkaline powdered detergent engineered to produce superior cleaning results for the removal of the toughest contaminants on all FERROUS metal surfaces. A powerful rust stripper that provides a one-step cleaning process that eliminates acid pickling, neutralizing, and rinsing steps.

PowerRail P/N	Size	Comment
AQUASOLVE-5	5 Gallon	Liquid
SPRAYDETRS-50	50 lb	Pail
SPRAYDETRS-50	450 lb	Pail





**CHEMICAL LINE (con't)**



**DEFOAMER O**

A highly concentrated, non-silicone, liquid foam suppressant that is compatible when used with all SPRAYDET detergents when additional foam control is necessary.

Specifically designed to quickly eliminate foaming caused by certain equipment types & designs, water quality, types of soils being cleaned and heavy soil loading.

Provides superior foam control in wash and rinse sections of all aqueous industrial parts washers from heated high-pressure spray cabinet & conveyORIZED systems to free standing manual and immersion type tanks.

PowerRail P/N	Size	Comment
DEFOAMER-5	5 Gallon	Liquid



**DIRT BUSTER KIT**

A heavy duty, aluminum safe, high pH, alkaline multipurpose degreaser and detergent capable of cleaning and degreasing everything from hard-surface concrete shop floors & walls, to industrial equipment, to company vehicles.

Packaged as an EZ Kit for greater economy. Contents include 2 - 2.5-gallon jugs that when mixed together produce 30 gallons of super concentrate.

PowerRail P/N	Size	Comment
DIRTBUSTER-25	2.5 Gallon	Package



**EZ SPREAD ICE MELT**

A fast, efficient, calcium chloride based ice melt packaged in a safety-oriented lightweight EZ spread 10 pound bag capable of being dispensed using one arm only.

Highly effective at or above temperatures of -25°F!

Economic formulation requires less volume when compared to conventional salt-based ice melts and leaves no white stains or residue.

Railroad Approved for Weight Safety Practice!!!!

PowerRail P/N	Size	Comment
CAL-10	10 Lb	Bag
CAL-10SKID	10Lb	Qty 160 Bags per Skid





**CHEMICAL LINE (con't)**



**BioGuard Plus 6™**  
**Biocide and Multifunctional Diesel Fuel Additive**

**DESCRIPTION, FEATURES & BENEFITS**

The only EPA registered fuel microbiocide containing a multifunctional premium diesel additive. Contains **BioGuard™** microbiocide to prevent microbial contamination and fuel filter plugging. Formulated with **Diesel Guard™** to help prevent ultra low sulfur diesel and biodiesel related problems and significantly improve heavy-duty diesel engine performance. Helps reduce fuel consumption, smoke, soot, odor and harmful exhaust emissions.

Contains less than 15ppm of sulfur to comply with ultra low sulfur diesel regulations.

Product performance has been documented in ASTM, SAE and engine manufacturer tests.

**Continuous Use Helps To...**

- Prevent bacteria and other microbiological growth
- Stabilize fuel to keep it fresh for up to 2 years or more
- Improve thermal stability beyond industry standards
- Control moisture to prevent sludge
- Lubricate fuel injectors & pumps to prevent premature wear
- Prevent fuel filter plugging and extend fuel filter life
- Prevent rust & corrosion
- Increase cetane number
- Dosage 1 Gallon per 1500 Gallons Diesel
- Clean up and prevent fuel injector deposits
- Exceed Cummins L-10 “Superior” injector deposit cleanliness rating
- Reduce piston and combustion chamber deposits
- Increase power and performance\*
- Reduce smoke, odor, transom soot\*
- Reduce harmful exhaust emissions\*
- Contains no alcohol
- Eliminate the need for other fuel additives
- Reduce fuel consumption up to 7.6%\*

BGDP632	Qty 12 32 Oz Bottles per case
BGDP601	Qty 4 1 Gallon per case

BGDP625	Qty 2 2.5 Gallon per case
BGDP6-55	55 Gallon Drum

**SEASONAL PRODUCTS**

**688S - PORTABLE TOILET SUMMER**

A concentrated liquid odor control agent for use in chemical toilets in airplane, locomotive, RV, bus and portable toilet applications.

A liquid formulation that mixes readily with water, glycol or salt solutions.

No messy powder to handle or clean up.

Contains no hazardous or toxic ingredients.  
**NO FORMALDEHYDE.**



**688W - PORTABLE TOILET WINTER**

A concentrated liquid odor control agent for use in chemical toilets in airplane, Locomotive, RV, bus and portable toilet applications.

A liquid formulation that mixes readily with water, glycol or salt solutions.

No messy powder to handle or clean up.

Contains no hazardous or toxic ingredients.  
**NO FORMALDEHYDE.**

Provides protection from freezing down to -40°F

PowerRail P/N	Size	Comment
688S-55	55 Gallon	Liquid - SUMMER
688S-55	55 Gallon	Liquid - WINTER

### CIRCUIT BREAKERS

Complete Line of Heavy Duty Circuit Breakers.  
Below is a Listing of Common Items



PowerRail P/N	Amp	Comment
E8458705	2	SINGLE POLE
E8456915	5	SINGLE POLE
E8458697	10	SINGLE POLE
E8458698	15	SINGLE POLE
E8458699	30	SINGLE POLE
E8458735	3	DOUBLE POLE
E8458728	5	DOUBLE POLE
E8458736	5	DOUBLE POLE
E8458739	15	DOUBLE POLE
E8458727	15	DOUBLE POLE
E9090434	15	DOUBLE POLE
E8458724	30	DOUBLE POLE
E8458726	35	DOUBLE POLE
E8458738	40	DOUBLE POLE
E8414231	50	DOUBLE POLE

PowerRail P/N	Amp	Comment
E8448859	50	DOUBLE POLE
E8316879	50	DOUBLE POLE
E8433382	60	DOUBLE POLE
E8485669	60	DOUBLE POLE
E6945270	70	DOUBLE POLE
E8433383	100	DOUBLE POLE
E8433381	150	DOUBLE POLE
E8458741	15	TRIPLE POLE
E8458742	30	TRIPLE POLE
G41A218545P4	15	SINGLE POLE
G41B544907P1	15	SINGLE POLE
G41B544907P2	25	DOUBLE POLE
G41A212414P14	15	DOUBLE POLE
G41A212414P2	30	DOUBLE POLE

We also carry a complete Line  
of Electrical Buss Bars and Shunts



8280185 Main Battery Switch  
- 400 Amp/250 Volt

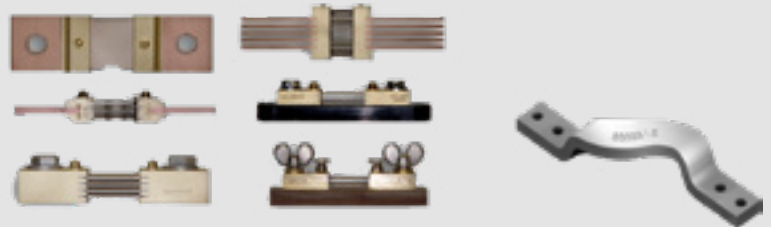

### CLAMPS

Complete Line of Clamps for Multiple Applications



### CONTACTS, ELECTRICAL WIRE & TERMINALS

Complete Line of Electrical Contacts,  
Wire and Terminals

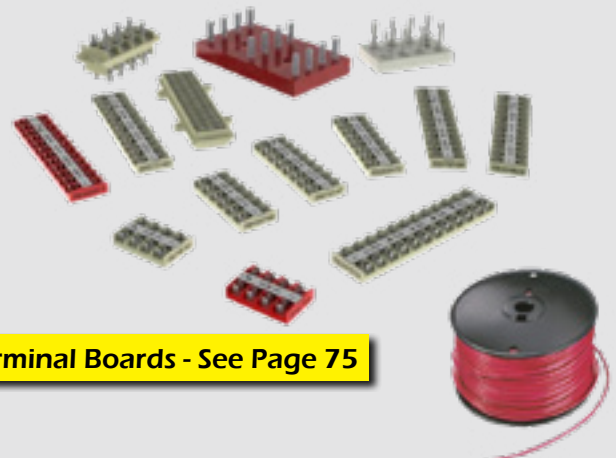

Terminal Boards - See Page 75

**COMPRESSORS - AIR & WATER**

Complete Line of New & Remanufactured  
WBO, WBG and W XO Air Compressors, Parts and Components



Compressor Test Cell

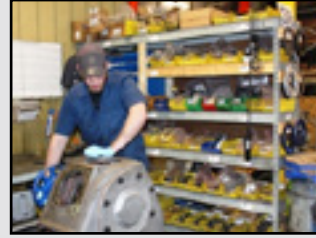

Quality Build Procedures



Remanufactured Components

<b>New and Remanufactured</b>	<b>Description</b>	<b>Type</b>
W XO	Air Cooled - 3 Cylinder	Low & High Base Single & Double Shaft
W BO	Water Cooled - 3 Cylinder	Low & High Base Single & Double Shaft
WLNA9 Series	Water Cooled - 3 Cylinder	Low & High Base Single & Double Shaft
WLAA9	Water Cooled - 4 Cylinder	Low & High Base Single & Double Shaft
W BG	Water Cooled - 6 Cylinder	Low & High Base Single & Double Shaft

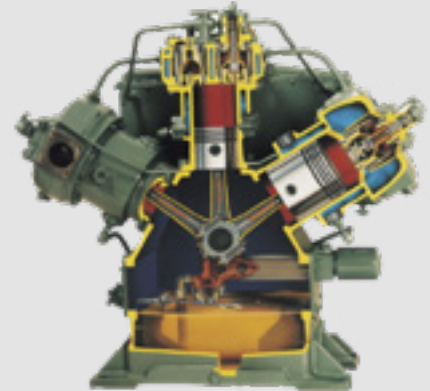

**MOTOR DRIVEN AIR COMPRESSOR**

Complete Line of Motor Driven Air Compressors utilizing PowerRail work scopes.  
All motors are rewound for Reliability & Durability.





**COMPRESSORS - AIR & WATER**

Complete Line of New & Remanufactured series  
WXO, WBO and WBG Air Compressors, Parts and Components

**Common Parts Listing By Air Compressor Model**

WXO LP Head	E8042133
WXO LP Cyl.	E8059939
WXO LP Piston	E40017901
WXO LP Rod	E8033545
WXO HP Head	E8033550
WXO HP Cyl	E8083614
WXO HP Piston	E8343422
WXO HP Rod	E8033545
WBO LP Head	E8237532 Both Styles
WBO LP Cyl.	E8237539 Old Style
WBO LP Cyl.	E9518774 New Style
WBO LP Piston	E8338021 Old Style
WBO LP Piston	E40017901 New Style
WBO LP Rod	E8033545
WBO ½ Bearing	E8496981
WBO HP Head	E8238541 Old Style
WBO HP Head	E8347435 New Style
WBO HP Cyl	E8237531 Old Style
WBO HP Head	E8347435 New Style
WBO HP Piston	E8343422 Old Style
WBO HP Piston	E40017901 New Style
WBO HP Rod	E8033545

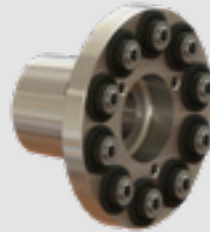

E8236433  
Coupling  
Air Compressor



E8323180  
Coupling  
Engine



E8234958  
Bushing

Valves New and Old Style	Description
E9319946	HP Valve Inlet
E8424969	HP Valve Outlet
E9319947	LP Valve Inlet
E8424968	LP Valve Outlet

Old Style = 8 Bolts from Underneath

New Style = 4 Bolts from Underneath & 4 from Top

**TOP DECK KITS**

Kits Include all Heads, Liners, Rods, Pistons, Rings, Bearings, Valves, Gaskets & Hardware to do a complete rebuild in the field. Kits available for WXO, WBO & WBG style compressors Unit Exchange or Outright



**CONTROL STANDS**

Full Line of New and Remanufactured Control Stands



New Stand Ready for Install



PowerRail Electronics Technology also Provides Full Service of Repaired Control Stands and Lockers



100% New & Remanufactured Controllers. Dynamic and Non Dynamic

PowerRail P/N	Description
E9093629	Dynamic Plastic Face
E8226959	Dynamic Steel Face
E9325903	Dynamic Plastic Face
E9091052	NON—Dynamic Plastic Face
E8227211	NON—Dynamic Steel Face

**Contactors, Controllers, Relays and Modules - See Page 25**



**New LED Dimmable Bulbs for Control Stands - See Page 10**



Custom Panels Related to PTC Installations

New Anti-Rattle Doors with Adjustable Locks

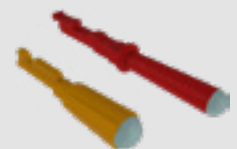
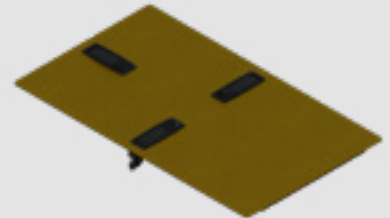

**Safety Handles - See Page 7**

**CONTACTORS, CONTROLLERS, RELAYS & MODULES**

Complete Line of Control Stands, Controllers, Contactors, Relay, Voltage Regulators and Modules.  
Our Line includes New and Unit Exchange

**Below is a BRIEF Listing of our Quality New & Rebuilt Products**

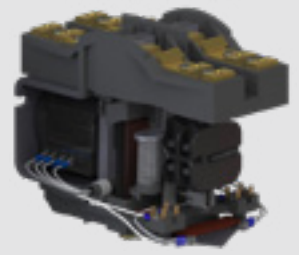
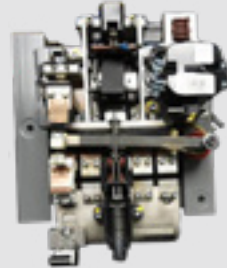
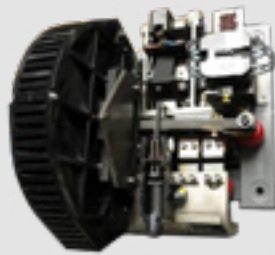
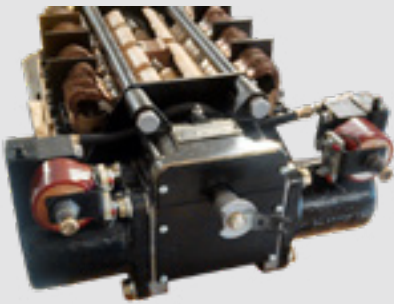

<b>PowerRail P/N</b>	<b>Description</b>
E8400143	Contactor Control Cabinet
E8251126	Contactor Gen. Shunt Field
E8192805	Contactor Power
E8458534	Contactor Power
E8461331	Contactor Magnetic
E8453175	Motor Module Control
E8463776	Motor Module Control
E9091052	Controller Non Dynamic
E9093629	Controller Dynamic & Brake
E9325903	Controller Dynamic & Brake
E8330790	Voltage Regulator 3 Terminal
E8351980	Voltage Regulator 4 Terminal
E8484375	6 Panel Light Enhancement
E9322456	Rheostat 1500 Ohms
E40040084	SGC 5000A Power Contactor
E8131665	Reverser 4 motor 4 Contact
E8131666	Reverser 2 Motor 2 Contact
G17FL & G17FM	Aux and Other Modular Panels

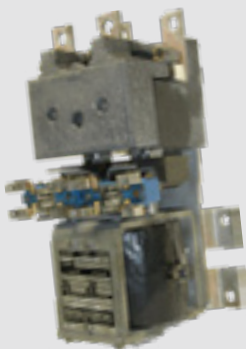

**COUPLERS, YOKES & DRAFT GEARS**

Complete Line of Heavy Duty  
AAR Certified Couplers, Yokes and  
complete Assemblies New & Unit Exchange

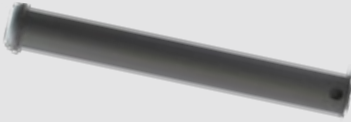

PowerRail P/N	Description
E8034983	Coupler Type E Non Alignment
E8219072	Coupler Type E Non Align Control 4888
E8349831	Coupler Type F Align Control 8301
E8385515	Coupler Type E Align Control 8311/8306
PRD16184269	Mark 50 for 100 Ton Train Cars
G499A423P10/E8420235	Draft Gear NC-390
E6915380/G499A180P6	Yoke Only NC 390
E8420236	Draft Gear and Yoke Assy NC 390
E8220283/E8252488	Single Draft Gear & Yoke Assy MS-485-6A
E8269424	Double Draft Gear & Yoke Assy MS-485-5A
E8246352	Draft Gear MS-485-5A
G343B261P1/E8253666	Draft Gear MS-485-6A
E8246351	Draft Gear
E8420237/G499A423P9	Draft Gear NC-391
E8420238/G41D71673G2	Draft Gear And Yoke Assy NC 391
E8314758	Yoke Only NC 391
E8062944	Lock Coupler
E8069851	Thrower Coupler
E8068119	Lifter Assembly Coupler
E8081918	Coupler Pin 3 15/16" x 13 OAL
E9500878	Coupler Pin 3 17/32" Dia. x 12 5/8" L
E9500877	Coupler Pin 3 17/32" Dia. x 13" L
E8057698	C10 Knuckle Pin
E8055811	Knuckle Type E50BE
PRD16184064	Block for Non Alignment Coupler

We Offer a Full Line of Parts for the  
Complete Coupler Section



New and Unit Exchange Draft Gears



NC-390 Draft Gear



NC-391 Draft Gear

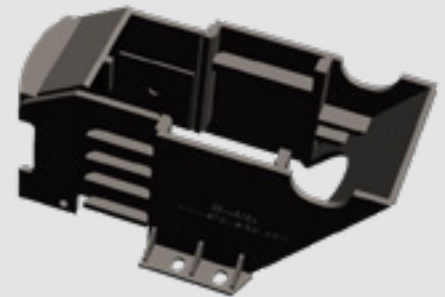

E8448086 Pocket



Full Line of Coupling Parts



PRD16184064  
Alignment Block for Pocket



## ELECTRIC SEMI-CONDUCTOR TESTER

### PowerRail DST5000 Tester

- Test SCR's/Thyristors
- Test Silicon Diodes
- Test Transistors/IGBT's
- Test Rectifiers
- Test IGTS's



### Three Very Important Tests:

- Adjustable from zero to 5,000V for testing Forward Blocking. Digital Ammeter indicates leakage current at semiconductor voltage rating.
- Adjustable from zero to 5,000V for testing Reverse Blocking. Digital Ammeter indicates leakage current at semiconductor voltage rating.
- Adjustable voltage for Gating or Firing devices. Digital DC Voltmeter indicates actual gate trigger voltage (VGT). Digital DC Ammeter indicates actual gate current (LGT).

## ELECTRICAL - ELECTRONIC

Complete Line of Quality Electrical Lighting,  
Resistors, Diodes, Thyristors and other  
related components



PowerRail P/N	Description
E40048214	Insulating Diode Boot
E40029131	AR10 Diode Negative
E40029132	AR10 AR11 Diode Positive
E40032602	AR20 Diode Positive
E40032603	AR20 Diode Negative
E40053999	Diode Positive
E40032602	Diode Negative
E8374003	AR10 Transformer
E9561605	AR11 Transformer
E8380922	Resistor AR10 50W 5 OHMS
E8429166	Resistor 400W 3.75 OHMS
E8004092	Walkaway Step Light
E8004613	Engine Room Light Globe Glass
E8332375	Rubber Standard Lamp Base 4 Holes
E8332374	Rubber Standard Lamp Base 2 Holes
E8207382	Engine Room Guard and Shade Assembly
E8047227	Lamp Guard Assembly Cage
E8228323	Number Light Socket Lamp - Yellow Rubber
E8332375	Socket Lamp, 4 Holes, Rubber - Standard Base

**ENGINES**

Complete Line of Quality Remanufactured Engines



**POWERRAIL ENGINE SYSTEMS**  
CREATIVE INNOVATIONS...CONTINUING TRADITION

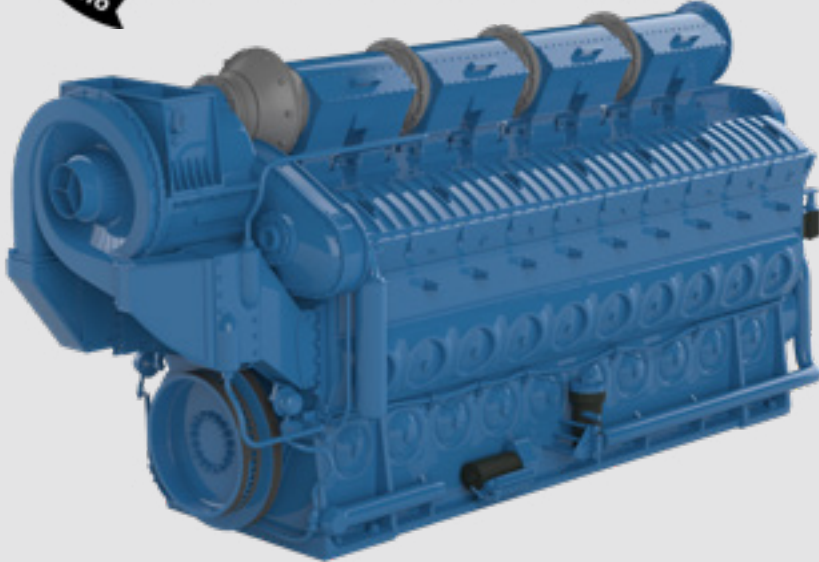

We proudly supply a complete line of remanufactured Engines and Engine Components for the rail industry.

We offer a wide range of 567 - 645 - 710 and 7FDL Type Engines that can support most programs. Options include Unit Exchange, Remanufactured Outright, and Repair/Return.

All Engines are mounted on a Dynamometer to ensure quality and reliability. Our shop is AAR M-1003 Certified and the quality and experience of our staff has earned approvals by most Short Line, Regional, Class I, and International Railroads.



We also offer FULL Engine Service & Field Support, including Line Boring.



**QUALITY**  
& RELIABILITY  
**IS JOB #1**



### ENGINE PARTS OFFERING

Complete Line of New Engine Parts & Components  
Below is a sampling of our broad range of offerings



**POWERRAIL ENGINE SYSTEMS**  
CREATIVE INNOVATIONS...CONTINUING TRADITION



• Camshafts	• Crabs & Bolts	• Cross Heads	• Cylinder Test Valves
• Cylinder Heads	• Engine Protectors	• Fuel Lines	• Fuel Pumps
• Gears	• Hand-Hole Covers	• Liners	• Oil Lines
• Oil Pumps	• “P” Pipes	• Piston & Rings	• Push Rods
• Rods/Carriers	• Water Elbows	• Water Jumpers	• Water Pumps



### Common Stock Parts

PowerRail P/N	Description
E8028006	Thrust Collar 645
E8039842	Lube Oil Line
E8048880HANDLE	Cylinder Test Valve 645 T-Handle
E8085260	Valve Bridge Assembly
E8135330	Trust Washer 645
E8160209	Fuel Line
E8195996	Flex Coupler
E8206804	Water Jumper 567C
E8414444	Water Elbow
E9093027	Water Jumper 645
E9319504	Rocker Arm Assy Injector 645
E9319505	Rocker Arm Assy Exhaust 645
E9544046	Thrust Collar 710
E9546230	Rocker Arm Assy Injector 710

PowerRail P/N	Description
E9546232	Rocker Arm Assy Exhaust 710
E9549577	P Pipe 567
E9549578	P Pipe 645
E9581924	Cylinder Head Ring Viton
E40036607	Cylinder Test Valve 710
E40046561	P Pipe 710
E40102453	Trust Washer 710
G114X1218	Bonded Drive Couplings
G116X1114 / G116X1115	Cam Segment
G124X1058 / G124X1068	CrossHeads
G140X1826-1 / G140X2950	Fuel Line
G150X1232	Linkage
PRD16184502	Oil Sampling Valve ¼ NPT



## ENGINE - CAMSHAFTS, CRANKSHAFTS, STUBSHAFTS AND SPACERS

New and Reconditioned Camshafts, Crankshafts, Stubshafts and Spacers:

8 Cylinder 645 and 710 Series

16 Cylinder 645 and 710 Series

12 Cylinder 645 and 710 Series

20 Cylinder 645 and 710 Series

CAMSHAFTS	
PowerRail P/N	Description
E8261194/E8419849/E40082058	16 Cyl. 645 Series Segment
E8419910/E8274790/E9502033	16 Cyl. 645 Series Assembly
E8419911/E8274791/E9502034	16 Cyl. 645 Series Assembly
E8433603/E40035571	20 Cyl. 645 Series Assembly
E8491992/E8274792	8 Cyl. 645 Series Assembly
E9318994/E9502035	12 Cyl. 645 Series Segment
E8261443/E9318995	12 Cyl. 645 Series Segment
E9318996/E8274797	12 Cyl. 645 Series Assembly
E9318997/E8274796	12 Cyl. 645 Series Assembly
E9319320	16 Cyl. 645 Series Segment

CRANKSHAFTS	
PowerRail P/N	Description
E9323404	8 Cyl. 645 Series Crankshaft
E9546459	8 Cyl. 645 Series Crankshaft
E9547357	12 Cyl. 645 Series Crankshaft
E8440167	12 Cyl. ABS 645 Series Crankshaft
E8034708	16 Cyl. 645 Series Crankshaft
E8482822	16 Cyl. 645 Series Crankshaft
E8440023	16 Cyl. ABS 645 Series Crankshaft
E8360783	20 Cyl. 645 Series Crankshaft
E40048625	12 Cyl. 710 Series Crankshaft
E40109969	16 Cyl. 710 Series Crankshaft
E9569292	16 Cyl. ABS 710 Series Crankshaft



## ENGINE - CYLINDER TEST VALVES

- Class 1 Approved Design
- Solid One Piece Machined Nut in lieu of Welded Nut
- Designed for 567, 645 and 710 Series Engines
- Utilizes Standard 5/8" Socket, 6 or 12 Point

PowerRail P/N	Description
E8048880PRD	Cylinder Test Valve
E40036607PRD	Cylinder Test Valve
E40017341	Cylinder Test Cock Seal
E8048880HANDLE	Cylinder Test Valve w/ T-Handle Design



E8048880HANDLE  
T-Handle Design  
Also Available





### ENGINE FANS - COOLING & GRID

Full Line of New and Remanufactured Engine Fans and Electrical Grid Fans



PowerRail P/N	Description
E5526269	36" 12HP 10 Blade
E8311479	48" 28HP 6 Blade
E8310416	48" 35HP 8 Blade
E8379212	48" 35HP 9 Blade
E9517833	48" 50HP 8 Blade
E9576052	48" 50HP 8 Blade 2 Speed
E8281907	48" 18HP Resistor Grid Fan
E9514316	48" 36HP Resistor Grid Fan
E8388333	48" Fan Guard
E9096227	Air Cylinder 1 1/8 Stroke
E9569860	Air Cylinder 3 1/2 Stroke
E9558527	Fan Blade ONLY

### ENGINE GEARS

Complete Line of New and Remanufactured Engine Gears and Spring Drive Gears

PowerRail P/N	Description
E8483944	Drive Gear 58T
E8543203	Drive Gear 58T
E8483945	Drive Gear 58T
E8069019	Drive Gear 79T
E8360843	Drive Gear 79T
E8069014	Drive Gear 79T
E8360839 / E8141909	122 Acc. Drive Gear
E8416930	Starter Ring Gear 265T
E40051536	Starter Ring Gear 265T
E8416930-PRD3PC	Starter Ring Gear 265T 3-Pc



**645 & 710 Spring Drives**



PowerRail P/N	Description
E9515331	Spring Drive Gear High Capacity 16:8 to 1
E9515338	Spring Drive Gear Standard 18:1 ratio
E9538148	Spring Drive Gear Standard 18:1 ratio
E9538149	Spring Drive Gear High Capacity 16:8 to 1
E40001044	16cyl 710 Clutch UX
E40013863	16cyl 710 Clutch UX
E40028648	12cyl 710 Clutch
E40052862	20cyl 710 Clutch



## ENGINE - GOVERNORS

Complete Line of New and UX Woodward Certified Governors

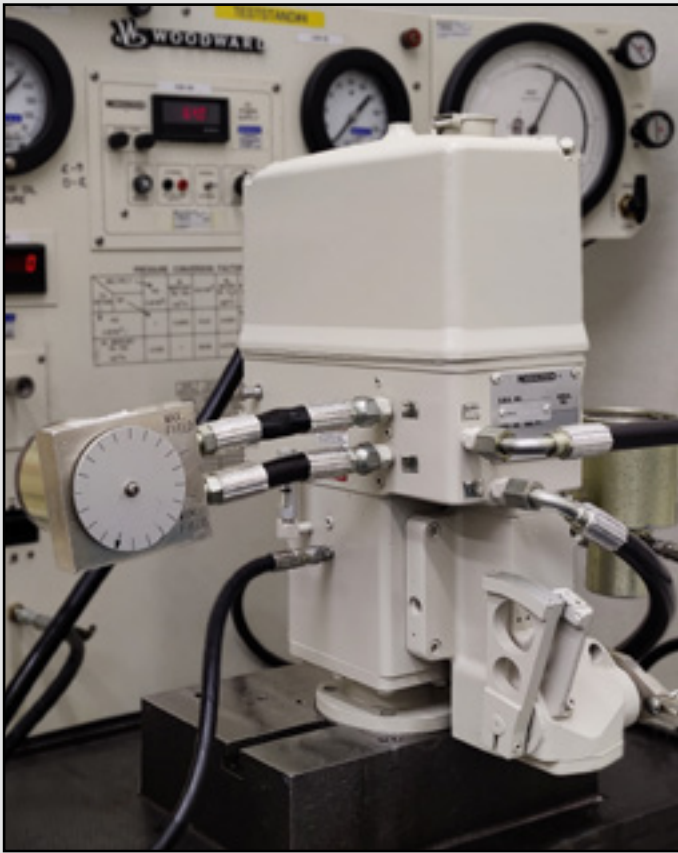

PowerRail P/N	Application
E40003898-UX	710G3, GP60/SD60
E40011851-UX	710G3, G3A, GP59, F59 (12-710G3A)
E40035516-UX	16-710 G3A (SD60)
E40043302-UX	16-645F3B
E8122755-UX	567B
E8122846-96-UX	567C
E9335713-UX	645E3, F40PH
E9551458-UX	645E3B, F40PH
E8424301-UX	12-645E, SW1000, SW1001
E8453388-UX	SW100, SW1001, SW1002, 12-645E
E8466183-UX	16-645E, GP38, SD38, SD38AC, SD38M, SD38-2, G18, G18B, GA18, G22
E8482396	8/12/16-645E Engines, SW1001, GP15-1, GP38, GP38AC, GP38-2, SD38, SD38AC, SD38-2
E8482413-UX	8/12/16-645, 8/12/16-645E, SW1001, GP15-1, GP38, GP38AC, GP38-2, SD38, SD38AC, SD38-2E
E8483536-UX	12/16/20-645E3, 16-645E3A, 8/12/16/20-645E3B, 8/12-645E3C, 12/16-645F3, and 8/12/16-645F3B, GP39, GP40, GP40-2, SD40, SD40-2
E9318853-UX	SW1500, MP15, 645E

With PowerRail Governors, the highest quality standards and requirements are factory-audited, ensuring strict compliance. Only genuine Woodward parts and certified, calibrated tools and test stands are used. A complete disassembly, bench inspection, comprehensive cleaning, reassembly and testing to OEM specifications occurs with each governor to ensure Woodward requirements are met.

- Governors available in Unit Exchange, Repair/Return or New
- Rebuilt by Certified Woodward Governor Specialists
- Rebuilt, Tested and Calibrated to OEM Specifications
- Large Inventory of Unit Exchange Governors on-hand, Ready to Ship
- Proven Reliability that Improves the Life of the Unit and Reduces Unplanned Downtime



## ENGINE - INJECTORS

Complete line of New and Remanufactured Fuel Injectors

PowerRail P/N	Application
E9081163	567B/567BC
E8478048	567C
E9081164	567D
E8478045	645E
E8478046	645E3
E8478053	645E3B
E8478055	645E3B Eco
E9561950	645F3B
G123X1110-2	7FDL-Style
G132X1710	Bryce Single Pump
G132X1645	Bryce Double Pump
G132X1715	Bendix Single Pump
G132X1535	Bendix Double Pump



Full Line of Injector Parts

### ECOTIP “Green Tag” Injectors

PowerRail P/N	ECOTIP Ref #	Comment
E8478049	40083527 / 40078996	567 A,B,BC,C,E Fuel Efficient Tip
E8478045	40083524 / 40078993	645E Roots Fuel Efficient Tip With Calibration Slide
E8478046	40083525 / 40078994	111 Fuel Injector 12,16, 20 Cylinder Low Smoke
E8478055	40083533 / 40079002	111 Fuel Injector Fits 645E3B

Green Tag Injectors offer very precise beginning and ending of fuel injection. This results in fuel savings at full load and on medium duty cycle. Reliability and durability is also increased due to lower peak cylinder combustion.

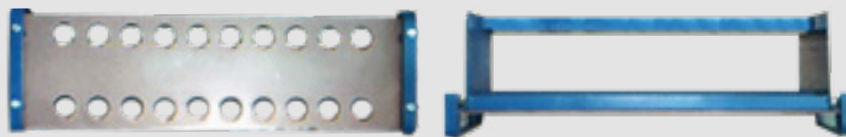

E8431626 - Holding Rack For Injectors

### “Black Tag” Extended Idle “Switcher” Injectors

PowerRail P/N	Engine Application	Body Style
E4991632	567B, BC, C	No-line
E4991635	567C	1 Narrow groove
E4991629	645E, 567C	1 Narrow groove

Black Tag Injectors are designed to overcome specific challenges under various applications. The benefits include reduced emissions and smoke with minimal to no fuel penalty in certain applications. The Injectors also help to reduce “souping” during extended idle situations.



**ENGINE - POWER ASSEMBLIES**

Complete Line of Premium New and Remanufactured Power Assemblies,  
HLP's, Cylinder Heads and other Related Parts

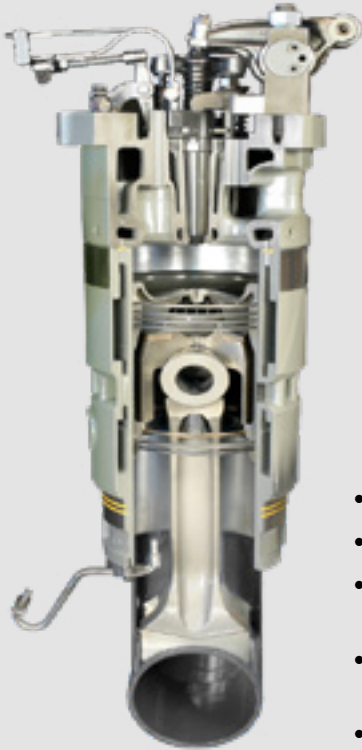

Type	New	UX
567B	No	Yes
567BC	No	Yes
567C	Yes	Yes
567CE	Yes	Yes
645E	Yes	Yes
645E3	Yes	Yes
645E3B	Yes	Yes
645E3C	Yes	Yes
710	Yes	Yes

GE Style - 7FDL	
G121X1240	G122X2601
G121X1244	G122X2610
G121X1250	G122X2611
G121X1254	G122X2650
G121X1260	G122X2651
G121X1264	G142X1070

- Machined & Assembled in USA
- Raw materials meet or exceed current OEM Specifications
- Proven Field Approvals with multiple OEM Builders, Class I, Regionals, Short Lines & Internationally
- Water jackets are thoroughly inspected via bore scope to ensure no debris or casting sand remains
- Over 39 checkpoints are measured and documented to ensure quality conformance
- State of the art casting techniques reduce porosity and maintain adequate coolant flow
- EPA emission compliant equivalents available

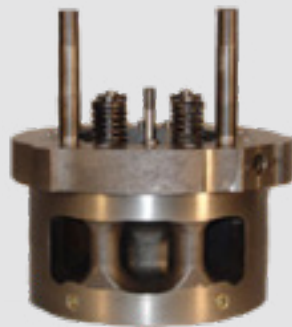
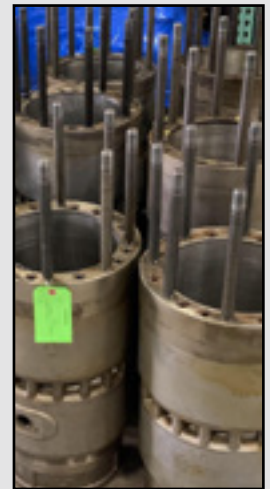

**POWERRAIL ENGINE SYSTEMS**  
CREATIVE INNOVATIONS...CONTINUING TRADITION

### POWER ASSEMBLY - PARTS

Complete Line of New Power Assembly Related Components  
Below is a sampling of our broad range of offerings



PowerRail P/N	Description	New	UX
E8415993	Liner Cast Iron 645	Yes	Yes
E9318833	Liner HUB 645	Yes	Yes
E9090233	Liner Chrome 645	Yes	Yes
E9546509/ E40014531	Liner HUB 710	Yes	Yes
E40060841	Fork Rod	Yes	Yes
E9544257	Blade Rod	Yes	Yes
E8367800	Carrier 645	Yes	Yes
E40006129	Piston Tin Plated HURG Roots	Yes	No
E40006130	Piston Tin Plated HURG 645E3	Yes	No
E40006131	Piston Tin Plated HURG 645E3B	Yes	No
E40033365	Ring Set CI Liner 645	Yes	No
E9323296	Ring Set Chrome 645	Yes	No
E8269842	Piston Pin 645E	Yes	Yes
E40078951	Piston Pin 645E3B	Yes	Yes
E8268641	Lower Liner Insert 645	Yes	No
E9316139	Lower Liner Insert Hi HP	Yes	No
E9583686	Power Assy Gasket Install Kit	Yes	No
G121X1306	Rotator Valve Cylinder	Yes	No
G142X1050	Piston	Yes	No
G142X1052	Piston Pin	Yes	No
G7FDL Style	Short Packs and Full	No	Yes



### ENGINE - PROTECTORS

Complete Line of New and Remanufactured Engine Protectors

PowerRail P/N	Description
E9535870	Turbo Delta P Rebuild Kits
E9535868	Turbo Type P Rebuild Kits
E8467306	Roots Type P Rebuild Kits
E9535869	Roots Delta P Rebuild Kits
E9332828UX	Turbo Delta P
E8446372UX	Turbo Type P
E8474255UX	Roots Type P
E9506013UX	Roots Delta P
E8362040UX	Crankcase Monitor
E8370362UX	Crankcase Monitor

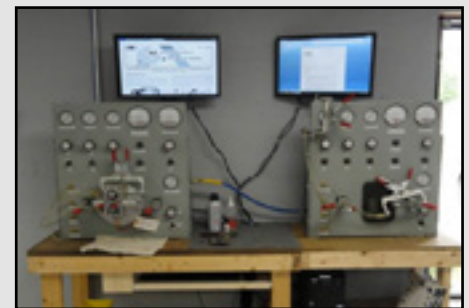
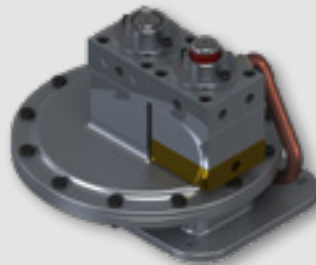

**ENGINE - PUMPS**

Complete Line of New and Remanufactured Fuel Pumps  
Utilizing Premium Parts and Components



**POWERRAIL ENHANCEMENT**

All Remanufactured Pump Motors offer NEW  
Armatures, Bearings and Brushes for Reliability

**FUEL PUMPS**

PowerRail P/N	Description	Comment
E5540387	¼ HP DC Fuel Pump Motor	with New Armature
E4947308	¾ HP DC Fuel Pump Motor	with New Armature
E8296428	¼ HP DC Fuel Pump & Motor	with New Armature
E40042770	¾ HP DC Fuel Pump & Motor	with New Armature
E8498154	Soak Back Pump 1.7GPM	Threaded Connection
E8152343	Soak Back Pump 1.7GPM Assy with Motor	Threaded Connection
E8498155	Soak Back Pump 1.7GPM	Flanged Connection
E8411403	Soak Back Pump 1.7GPM with Motor	Flanged Connection
E8498156	Soak Back Pump 3 GPM	Flanged Connection
E8492180	Soak Back Pump 3GPM Assy with Motor	Flanged Connection
E40009239	Soak Back Assembly ¾ HP 3GPM	Flanged Connection
E8080284	Fuel Pump 4GPM	½ NPT Threaded Connection
E8422951	Fuel Pump 6GPM	Flanged Connection
E8425609	Fuel Pump & Motor ¾ HP 6 GPM	Flanged Connection
E40042770	Fuel Pump & Motor ¾ HP 6 GPM	Flanged Connection
E40122943	AC 4GPM Transfer Pump	
E40095692	AC 4GPM Transfer Pump	
G132X1750	AC Transfer Pump	
G123X1645	Fuel Pump	Unit Exchange
G132X1535	Fuel Pump	UX - Bendix Type
G149X1014	Fuel Pump	Unit Exchange

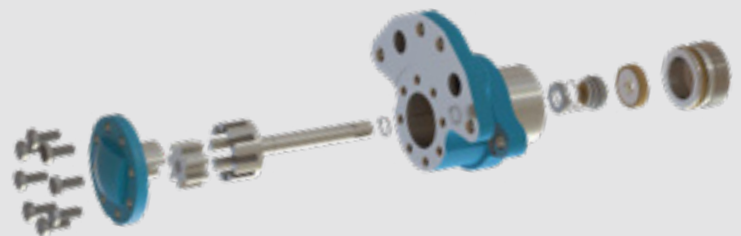

**ENGINE - PUMPS**

Complete Line of New and Remanufactured Water and Oil Pumps  
Utilizing Premium Parts and Components

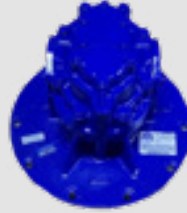

**OIL PUMPS**

PowerRail P/N	Description	Application
E8176033	Piston Cooling Pump	8-567/8-645E
E8122947	Lube Oil / Piston Pressure	12-567 / 8-645E
E8122949	Lube Oil / Piston Pressure	16-567 & 16-645 Roots 12-645 Turbo
E8296366	Lube Oil / Piston Pressure	16-567 / 16-645 / 12-710
E40055149	Scavenging Oil Pump	16-710G



Balancing Impeller



Precise Positioning



**WATER PUMPS**

PowerRail P/N	Description	Application
E9516925	Water Pump Left Hand SMALL	Roots Blown
E9516924	Water Pump Right Hand SMALL	Roots Blown
E9503461	Water Pump Left Hand Small	Turbo 16-567/12-645
E8296348	Water Pump Right Hand Small	Turbo 16-567/12-645
E9503461	Water Pump Left Hand Small	High Capacity
E9332825	Water Pump Left Hand Large	Turbo 16-645 - 710
E9510677	Water Pump Right Hand Large	Turbo 16-645 - 710
E40059826	Water Pump Right Hand	Tier 1
E40054890	Water Pump Left Hand	Tier 1
G125X1111	Water Pump	Unit Exchange



Torquing per MI



Precise Production



**ENGINE - ROCKER ARMS AND VALVE BRIDGES**

Complete Line of New and UX Rocker Arms and Valve Bridges  
for 567, 645 and 710 Type Engines

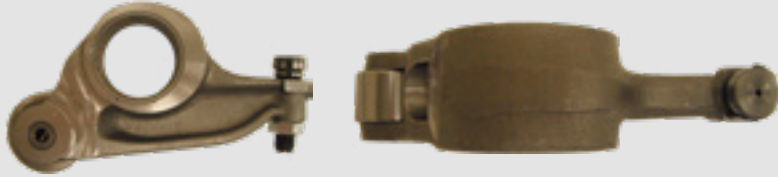

**POWERRAIL ENGINE SYSTEMS**  
CREATIVE INNOVATIONS...CONTINUING TRADITION

PowerRail P/N	Description
E9546230	Rocker Arm Assembly 710 Injector
E9546232	Rocker Arm Assembly 710 Exhaust
E9319504 / E9319504HH	Rocker Arm Assembly 567 and 645 Injector
E9319505 / E9319505HH	Rocker Arm Assembly 567 and 645 Exhaust
E40052184HH	Rocker Arm Assembly 645 Complete Set, Heavy

**Replacement Parts**

E9571921 Bushing  
E9571597 Roller  
E8031925 Button Retaining Spring  
E8328695 Body only

PowerRail P/N	Description
E8085260	Valve Bridge Old Style
E40126370 / 40145929	Valve Bridge New Style



645 Heavy Complete Set - E40052184HH

**Replacement Parts**

E8054088 Bridge  
E8068791 Spring  
E8028126 Seat  
E8028136 Ring  
E8052307 Button  
E8085254 Lash Adjuster



E8085260 - Valve Bridge Old Style  
E40126370/40145929 - Valve Bridge New Style



**Valve Bridge Gauge Forks**

E8107788      0.0625  
E40146269    0.140  
E40146267    0.060  
E40146268    0.100



**ENGINE - ROOTS BLOWERS**

Complete Line of New and Remanufactured Roots Blowers

Patented and proven **PowerSeal** that eliminates failure due to oil leaks.



PowerRail P/N	Description
E8379666	NEW Roots - Right Hand
E8379667	NEW Roots - Left Hand
E8379666UX	UX Roots - Right Hand
E8379667UX	UX Roots - Left Hand



All Rebuilt Roots Blowers are Bench Tested



All Scrolls are Precision Balanced



E8189438 Housing



E8369675 Bearing



E8065752 Gear Cover



E8204451 End Plate



E8028594 Quill Shaft



E8206553 Bearing



E8028466 Thrust Washer

### EPA Compliant Engine Kits

PowerRail proudly offers a complete line of EPA compliant Engine Kits, including:

- Level 2, Tier 0+ (1033 or 1042)
- Level 2, Tier 0+ (1033) 645E 12 Cylinder
- Level 2, Tier 0+ (1033) 645E 16 Cylinder

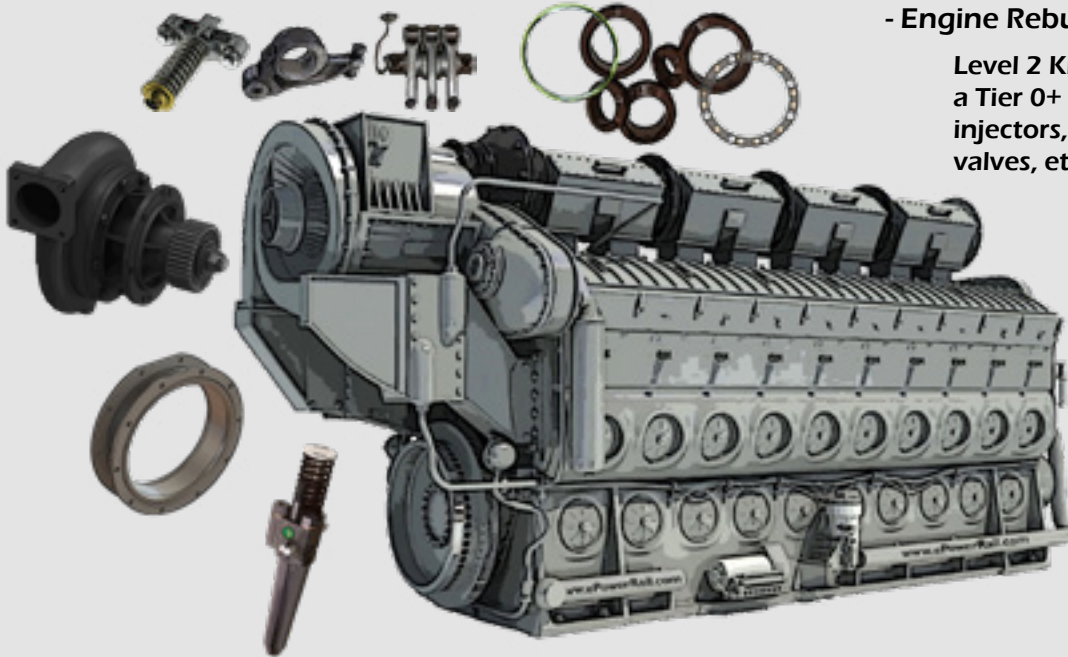

Other Available Engine Kits include:

- Top Deck Overhaul Kits
- Main Engine Bearing Kits
- Engine Rebuild Gasket Kits

Level 2 Kits include everything needed for a Tier 0+ Engine Kit, (pumps, blowers, fuel injectors, gaskets, bearings, turbos, test valves, etc.)

### Custom Inspection Kits

PowerRail proudly offers cost-efficient and time-saving custom Inspection Kits. Provide us with your maintenance schedule (92-day, 180-day, 360-day) and we'll have the Kits ready to ship when you need them.

- Assembled and tagged by customer's Road Number... easy ordering for you!
- Reduced inventory on your shelves
- No more picking and sorting to assemble kits on-site
- Reduced downtime with a more streamlined and efficient ordering process



Inspection Kits can include various consumables, such as:

- Carbon Brushes
- Filters
- Light Bulbs
- Wiper Blades
- Fuses (just to mention a few)

Your kit...your way!

**EXHAUST PRODUCTS**

Complete Line of Exhaust Chambers, Expansion Joints and Full Systems.



567 Chambers - 645 Chambers - 710 Chambers



PowerRail P/N	Description	Application
E9316231	Chamber Assembly 12-645	Exhaust - Front
E9516746	Chamber Assembly 12-645	Exhaust - Rear
E9316231	Chamber Assembly 16-645	Exhaust - Front
E9316232	Chamber Assembly 16-645	Exhaust - Intermediate Front
E9316233	Chamber Assembly 16-645	Exhaust - Intermediate Rear
E9316234	Chamber Assembly 16-645	Exhaust - Rear
<b>*Please Call for 567 &amp; 710 Chamber details</b>		



**THERMASEAL**

- Increased Thickness for INCREASED Bolt Retention
- Ceramic-filled with Proprietary Material to Increase Working Temperatures of approx. 2,000° F.

PowerRail P/N	Description	Application
E8408987	Expansion Joint 10"	Adaptor to Turbo
E8408985	Expansion Joint 14"	Exhaust Chamber
E40026936RED	High Heat ThermaSeal Gasket 21.625 OD x 18.875 ID, 12 Bolt Holes	Exhaust Chamber
E40026937RED	High Heat ThermaSeal Gasket 18.375 OD x 16.00 ID, 9 Bolt Holes	Expansion Joint to Chamber
E40055466RED	High Heat ThermaSeal Gasket - All Metal 410 Stainless Non-Graphite Design	Exhaust Chamber
E40026939RED	High Heat ThermaSeal Gasket 13.625 OD x 11.25 ID, 10 Bolt Holes	Expansion Joint to Turbo
E8287827PRD	Bolt ½-20 x 2 Hex Head B14	Expansion Joint Exhaust
E9338626	Nut ½-20 Silver Plated 316 Stainless Steel	Exhaust Manifold - Expansion Joint
E9557143	Turbo Screen Assembly 410 Stainless Steel Screen Starburst Design	645
E40155024	Turbo Screen Assembly	710



## EXHAUST PRODUCTS

Complete Line of Exhaust Chambers, Expansion Joints and Full Systems

<b>PowerRail P/N</b>	<b>Description</b>	<b>Application</b>
G128x1353-4	Manifold Section	for Single Pipe Manifolds
G128x1404	Clamp	for Single Pipe Manifolds
G128x1413	Gasket At Turbo Transition	for Dual Pipe Manifolds
G128x1444-7	Transition Section	for Single Pipe Manifolds
G128x1495	Complete Manifold	8 Cylinder - SS Version
G128x1496	Manifold Section - Leg 1R & 4R	8 Cylinder - SS Version
G128x1497	Manifold Section - Leg 1L & 4L	8 Cylinder - SS Version
G128x1498	Manifold Section - Leg 2R & 3R	8 Cylinder - SS Version
G128x1499	Manifold Section - Leg 2L & 3L	8 Cylinder - SS Version
G128x1629	End Cover	for Dual Pipe Manifolds
G128x1635	Main "T" Section	for Dual Pipe Manifolds
G128x1636	Bellows Connector	for Dual Pipe Manifolds
G128x1637	Gasket At Sections	for Dual Pipe Manifolds
G128x1638	Transition Section	for Dual Pipe Manifolds
G128x1639-1	V-Band Clamp	for Dual Pipe Manifolds
G128x1640-2	Complete Manifold	16 Cylinder Dual Pipe
G128x1642-2	Complete Manifold	12 Cylinder Dual Pipe
G128x1648-1	Transition Section	for Dual Pipe Manifolds
G128x1657	Manifold Section - Leg 1R & 4R	8 Cylinder - SS Version
G128x1658	Complete Manifold	8 Cylinder - SS Version
G128x1659	Manifold Section - Leg 1L & 4L	8 Cylinder - SS Version
G128x1660	Manifold Section - Leg 2R & 3R	8 Cylinder - SS Version
G128x1661	Manifold Section - Leg 2L & 3L	8 Cylinder - SS Version
G128x1670	Complete Manifold	12 Cylinder Dual Pipe
G128x1730	End Section	



## FASTENERS

Complete Line of Fasteners, Including Nuts, Bolts, Washers, Screws, and More



General Fasteners	
PowerRail P/N	Description
PRD12538-0008	Fastener Kit (For 8004092 Step Light)
E40055467	5/8 -18 x 4 1/4 Chamber To Crankcase
E8029567	1 1/4-12 x 2 3/4 Flange Retaining Bolt
E8034693	3/8 -24 X 2 1/2 - 7/16 Camshaft Bolt
E8127868	5/8 -18 x 1 3/4 Upper Forkrod Basket
E8159340	Bolt Assly Piston Pin to Connecting Rod
E8242193	1 3/8 -6 x 3 Axle Cap Bolt
E8261288	3/4-16 x 1 5/16 Bolt
E8266137	1 1/4-12 x 7 Special Bolt
E8322027	1-8 x 7 1/2 Gear Case Safety Strap T-Bolt
E8460207	5/8 -18 x 3 1/4 Assly Exhaust Chamber Bolt
E9085894	1 3/4-12 X 15 5/8 Crab Bolt
E9338626	1/2-20 Exhaust Manifold Nut
GN170P25024	3/8 -16 x 1 1/2 Coupling To Hub Bolt
G115X2588	1/2-13 x 2 1/4 Support To Turbo Bolt
G41A232240P1	1 1/2-6 x 5 Gear Case w/ Hole in Center
G142X1034-2	1/2-20 x 3 13/16 12Pt. Bolt Crown
G121X1186-1	1 1/4-12 x 8 11/16 Cylinder Hold Down Bolt
G115X2727	Banjo Bolt

Specialty Locomotive Engine Bolts	
PowerRail P/N	Description
E8300183	2 3/4-8 Nut Pinion Retaining D77
E8127868	5/8 -18 x 1 3/4 Bolt w/ Washer
E8259128	1/2-20 X 2 3/4 Bolt Lower Basket Assembly
E8260114	1 7/32 ID X 1 Washer Connecting Rod
E8460207	5/8 -18 x 3 1/4 Bolt Assly Chamber Exhaust
E8487883	1/2-20 Locknut Lower Basket Assembly
GN733P29024PRD	1/2-13 x 1 1/2 12Pt. Flange Bolt
GN763P39080	1-8 x 5 Hex Flange Head Bolt
E436591	10-32 x 7/8 Pan Head Screw
GN733P33020	5/8 -11 x 1 1/4 12 Point Flange Bolt
G115X2460	Washer Sealing
G115X2025-1	5/8 -11 x 1 3/4 Bolt
G115X2588	1/2-13 x 2 1/4 Bolt Support To Turbo
G41A231439P15	5/16 -18 x 5/8 Bolt Assembly
G41A235717P8	3/8 -16 x 1 1/4 Indented Bolt
G121X1109-1	Stud Nozzle Hold Down
G124X1010-8	Screw w/ Button Tappet
G142X1034-2	1/2-20 x 3 13/16 12Pt. Bolt Crown To Skirt

**\*Many More Fasteners Available - Call For More Details\***



## FILTERS

Complete Line of New Air, Fuel & Oil Filters

We can provide filters in broken case lots or save on Inventory Cost by purchasing kits

### Air Filters

Type	PowerRail P/N	Description
AA-1	G41C625459P1	12 x 8 Auxiliary Cabinet Cylindrical Element
AB-10	E8363343	7¾ x 5¾ Salem #824 Coalescer Element
AE-1	G41A216508P4	16 x 9 Engine Intake Cylindrical Element
AE-15	E9316812	22 x 14 x 6 Pleated Paper Tri-cell Engine Intake Element
AE-25	E9093588	36 x 14 x 6 Pleated Paper Tri-cell Engine Intake Element
AE-30	E9093587	45 x 14 x 6 Pleated Paper Tri-cell Engine Intake Element
AE-520T	E9331452	20 x 20 x 5 Pleated Paper Tri-cell Engine Intake Element
AE-529	E9331454	29 x 20 x 5 Pleated Paper Tri-cell Engine Intake Element
AK-2	E8402068	12 x 8 Cylindrical Air Compressor Intake
AK-3	E8347199	19½ x 5 7/8 x 8 Pamic-style Air Compressor Intake
DP240-0922	E8310098	9 x 20 x 2 30/30 Carbody Pleated
DP240-1620	E40087224	16 x 20 x 2 30/30 Carbody Pleated
DP240-1625	E8367085	16 x 25 x 2 30/30 Carbody Pleated
DP240-2020	E40083927	20 x 20 x 2 30/30 Carbody Pleated
DP240-2025	N/A	20 x 25 x 2 30/30 Carbody Pleated
EG-1	E8470903	29 x 27 x 6 Standard Filter Baggie
EGP-1	E40086945	29 x 27 x 6 Standard Filter Baggie - LONG LIFE 180 Day
EG-2	E9522063	19 x 22 x 5 Small Filter Baggie
EGP-2	G84C622136P1	19 x 22 x 5 Small Filter Baggie - LONG LIFE 180 Day
FP0922	E8310098	9 x 22 x 3¾ Fiberglass Carbody Pad
FP0922MOD	E8310098ALT	9 x 22 x 3¾ Fiberglass Carbody Pad w/ Cardboard Surrounding
FP1625	E8380459	16 x 25 x 3¾ Fiberglass Carbody Pad
FP2020	E8280211	20 x 20 x 3¾ Fiberglass Carbody Pad
FP2020MOD	E8280211CPMOD	20 x 20 x 3¾ Paper Long Life Carbody Pad
ICE-1010	E40041374	9½ x 10¾ x 1½ Cabin Electronics
PA2580	E9093553	12¾ x 23½ Engine Air Intake Cylindrical Element

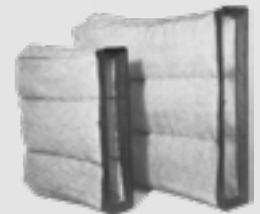
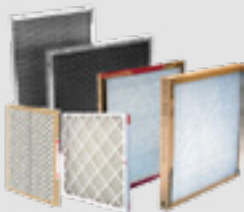

### Fuel Filters



Type	PowerRail P/N	Description
C-132XF-2	N/A	6 ½ x 30 Fuel Element Standard-life
CMAX-12	CMAX-12	6 ½ x 30 Max. Capacity
CMAX-184H	N/A	6 ½ x 30 Ultra-Max. Capacity
CMAX-24	CMAX-24	6 ½ x 30 Max. Capacity
FF-1B	E8299457	2 ½ x 7 ¾ Roll-Pak Sock Element
FH-1B	E8302891	3.38 x 9.75 Fuel Filter w/ Spring
FJ-2S	E8423132	3 ¾ x 7 Fuel Spin-on
FJ-33S	E40052587	3 ⅝ x 8 ½ Fuel Spin-on
FJ-44S	E40053463	5 ⅝ x 9 ½ Fuel Spin-on
FL-2W	G41B514746P1	2 ¾ x 8 ¾ Suction Strainer w/ Spring
FL-3W	E40061834	2 ¾ x 8 ¾ Suction Strainer w/ Spring
HA-1P1S	G132X1818	9 ⅞ x 30 One Stage Fuel Filter
HA-1P2S	E9545152	9 ⅞ x 30 Two Stage Fuel Filter
HA-2P1SF	E40074677	9 ⅞ x 30 2-piece One Stage Fuel Filter
HA-2P2SF	E40056007	9 ⅞ x 30 2-piece Two Stage Fuel Filter
HAF-2P2SF	G84D721178P2	9 ⅞ x 30 2-piece Two Stage Fuel Filter
HAF-3P2S-45	E40106208	9 ⅞ x 45 3-piece Two Stage Fuel Filter
HE-2P1SF	N/A	9 ⅞ x 30 2-piece One Stage Fuel Filter
HMAX-2P1S	EMD/GE type	9 ⅞ x 30 2-piece One Stage Fuel Filter Extended-Life
HMAX-2P2SF	HMAX-2P2SF	9 ⅞ x 30 2-piece Two Stage Fuel Filter Extended-Life
S-2	E8275432	6 x 30 Roll-Pak Sock Element
S-6	E8281232	6 x 28 ½ Flow-thru with Single Seal Sock Element



Type	PowerRail P/N	Description
BT267	E9311037	4 x 6 Air Compressor Spin-on
C-12/C-24	E8345482	6 ½ x 30 Standard-life Lube Oil
C-52	G2X4223	6 ½ x 30 Long-life
CMAX-12	CMAX-12	6 ½ x 30 Long-life Lube Oil Filter
CMAX-184H	N/A	6 ½ x 30 Long Life Lube Oil Filter Ultra Cap.
CMAX-24	CMAX-24	6 ½ x 30 Max. Capacity
CMAX-52	N/A	6 ½ x 30 Max. Capacity
FG-3W	E9324489	3 x 5 ¼ Lube Oil Suction Strainer
TL-2C	E8322064	4 ½ x 20 Turbo Standard-life Element
TL-2FSO	E40035123	5 ½ x 12 Turbo Spin-on Long-life
TL-3C	E8340000	3 x 7 ¼ Soak Back Spin-On Standard-life
TL-3FSO	E40058635	3 x 7 ¼ Soak Back Spin-On Long-life

## **PowerRail Flexi-Filter Generic Kits**

PowerRail provides a true cost savings by offering Customs Kits dedicated to the Railroad’s Road Units.

PowerKits will be custom assembled and tagged by the customers Road Unit number, making ease of ordering in the future.

In addition to Filters Kits, we also offer custom kits for Light Bulbs, Carbon Brushes, Wiper Blades, Fuses, and more.



<b>GP40 FILTER CHANGE OUT KIT</b>		
Qty	Part #	Description
8	E8345482	C-12/C-24 Lube Filter
1	E8275432	S-2 Primary Fuel Filter
2	E8423132	FJ-2S Secondary Fuel Filter Spin-on
1	E8322064	TL-2C Turbo -Paper Cartridge
1	E8340000	TL-3C Soak Back
1	* E9330535	AK-2 Air Compressor Intake Filter
1	* E8347199	AK-3 Air Compressor Intake Filter
1	E9311037	BT-267 Air Compressor Lube Filter
2	E8343161	Gasket Fuel Strainer/Soak Back
1	E8358905	Gasket Primary Fuel
1	E8268756	Gasket Lube Oil
1	E8288955	Gasket Turbo
* Note - May need EG-1 or EG-2 Baggies Intake Filters		

<b>EMD SW1500 FILTER CHANGE OUT KIT</b>		
Qty	Part #	Description
4	E8345482	C-12/C-24 Lube Filter
2	E8275432	S-2 Primary Fuel Filter
1	* E9330535	AK-2 Air Compressor Intake Filter
1	* E8347199	AK-3 Air Compressor Intake Filter
1	E9311037	BT-267 Air Compressor Lube Filter
1	E8343161	Gasket Fuel Strainer

<b>GP40 FILTER CHANGE OUT KIT</b>		
Qty	Part #	Description
7	E8345482	C-12/C-24 Lube Filter
1	E8275432	S-2 Primary Fuel Filter
2	E8423132	FJ-2S Secondary Fuel Filter Spin-on
1	E8322064	TL-2C Turbo -Paper Cartridge
1	E8340000	TL-3C Soak Back
1	* E9330535	AK-2 Air Compressor Intake Filter
1	* E8347199	AK-3 Air Compressor Intake Filter
1	E9311037	BT-267 Air Compressor lube Filter
2	E8343161	Gasket Fuel Strainer/Soak Back
1	E8358905	Gasket Primary Fuel
1	E8288955	Gasket Turbo

<b>EMD GP38 FILTER CHANGE OUT KIT</b>		
Qty	Part #	Description
7	E8345482	C-12/C-24 Lube Filter
3	E8470903	EG-1 Baggie Intake Filters
1	E8275432	S-2 Primary Fuel Filter
2	E8423132	FJ-2S Secondary Fuel Filter
1	* E9330535	AK-2 Air Compressor Intake Filter
1	* E8347199	AK-3 Air Compressor Intake Filter
1	E9311037	BT-267 Air Compressor Lube Filter
1	E9324489	FG-3W Fuel Strainer
1	E8358905	Gasket Primary Fuel
1	E8343161	Gasket Fuel Strainer

**Note: The Above Tables Reflect a Sampling Only.  
Custom Kits will be made per YOUR specs.**



### FILTERS - COALESCING

Full Line of Filters for Coalescing and Air Dryers

PowerRail P/N	Alt Part #	Description
E10565991	75-018	Air Dryer Repair Kit 3" O.D. x 11" L
E40086698	125-132	Coalescing Element Kit - Salem 824 Filter
E40015249	5237-30-0	Coalescing Filter Assem- bly - Salem 818 Filter
E40054494	P40968	Coalescing Filter Element Outer For PM5039
E40028168	5664-013	Filter Element for 975-075 3" I.D. x 6" L Main Reservoir
G5X1109	PM5015	Main Element and End Housing Kit for PM548



### FUSES

Complete Line of Electrical Fuses



PowerRail P/N	Amp	Application
E8004544	150A	Aux. Generator
E8004545	100A	Battery Charging
E8004546	60A	Alternator Field
E8004570	80A	Battery Field
E8004548	30A	Generator Field
E8060582	400A	Starter Motor
E8042739	400A	Fuse Link Starter
E8127051	150A	Boiler
E8152419	60A	Battery Field
E8346478	800A	AR10
E8407729	425A	AR12
E8414678	800A	Starter Motor
E8439559	200A	Cooling Fan
E9330514	450A	AR11 Transition
E9330515	450A	AR11 Transition
E40028900	550A	AR11
E40084060	500A	SD70 Air Compressor

### FUSE HOLDERS

Complete Line of Fuse Holders



Fuse Holder PP50026-5



Fuse & Torpedo Holder  
PP50026-16



Fuse & Torpedo Holder  
PP50026-23

PowerRail P/N	Description
E8280183	31-60 Amp 250 Volt
E8029220	60-100 Amp 250 Volt
E8280184	0-30 Amp 250 Volts
E8280180	61-100 Amp 3/8"-16 x 1 3/4"
E8280181	101-200 Amp 1/2"-13 X 2-1/4"
E8280182	201-400 Amp 3/4"-16 X 3-1/4"
E8280183	31-60 Amp 5/16"-18 x 1 3/4"
E8280185	Switch Main Battery Knife Style

# PowerSeal Solutions

A PowerRail Quality Company

## GASKETS, SEALS AND RUBBER PRODUCTS

Complete Line of New Generation Gaskets, Seals and O-Rings

PowerSeal Solutions offers a complete line of gaskets and seals including, our PS-1 Line, our PS-2 C-Swell™ Line for more demanding applications, and our newest addition...**The B-SureSeal™**.

### Marman Seals



#### PowerSeal B-SureSeal™ Marman Seals:

- Made with pure FKM and Viton® A-type material - NO fillers
- Injection molded for pure and high-precision fit with true reliability
- Superior performance through operating temperatures from -20°F to +400°F
- Resistance to oil, fuel, and additives
- Remains flexible in service and won't "set" like standard seals



**Pipe is always measured by the Outside Diameter (O.D.).  
Because a Marman Seal sits on the outside of the pipe, the I.D. of the  
Seal will be approximately the same size as the O.D. of the pipe.**

#### PowerRail P/N

#### Description

E8479542	Marman ½ Inch
E8479543	Marman ¾ Inch
E8479544	Marman 1 Inch
E8479598	Marman 1 ¼ In
E8479599	Marman 1 ½ In
E8479600	Marman 2 Inch
E8479601	Marman 2 ½ In
E8479602	Marman 3 Inch
E8479603	Marman 3 ½ In
E8479604	Marman 4 Inch
E8406231	Marman 6 Inch

Per ASTM D412-16 and D2240-15 testing, the PowerSeal B-SureSeal™ Marman Seals have greater tensile strength, superior elongation characteristics and half of the compression set when compared to other seals on the market.

This independent laboratory testing has shown the PowerSeal B-SureSeal™ Marman Seals to have improved physical properties, which directly translates into improved performance.

COUPLING ASSEMBLY		COMPONENT REFERENCE	
Pipe Outside Diameter	Assembled Coupling Length	Complete Assembly (PowerRail P/N)	Seal (PowerRail P/N)
0.5"	4.50"	E8476711	E8479542
0.75"	2.50"	E8479674	E8479697
0.75"	4.50"	E8470605	E8479606
1.00"	2.875"	E8470340	E8479544
1.00"	6.00"	E8476174	E8479544
1.00"	7.50"	E8472849	E8479544
2.00"	4.00"	E8474757	E8479600
2.00"	7.50"	E8479676	E8479600
2.50"	4.00"	E8392458	E8479538
2.50"	6.50"	E8472617	E8479538
2.50"	12.50"	E8472616	E8479538
2.50"	23.00"	E8275374	E8479601
2.50"	26.00"	E8284779	E8479601
2.50"	4.00"	E9516671	E8479601
3.00"	6.50"	E8471160	E8479539
3.00"	12.50"	E8468179	E8479539
3.00"	90°	E8455470	E8479539
4.00"	7.50"	E8252895	E8479541
4.00"	6.50"	E8474741	E8479541
4.00"	12.50"	E8470341	E8479541
5.00"	6.50"	E9559099	E40068473

# PowerSeal Solutions

A PowerRail Quality Company

## GASKETS, SEALS AND RUBBER PRODUCTS

### Dresser Seals



<u>PowerRail P/N</u>	<u>Description</u>
G499A912AEP2	Dresser 1/2"
G499A912AEP3	Dresser 3/4"
G499A912AEP4	Dresser 1"
G499A912AEP5	Dresser 1 1/4"
G499A912AEP6	Dresser 1 1/2"
G499A912AEP7	Dresser 2"
G499A912AEP8	Dresser 2 1/2"
G499A912AEP9	Dresser 3"
G499A912AEP10	Dresser 3 1/2"
G499A912AEP11	Dresser 4"
G499A912AEP13	Dresser 6"



### Gasket Fuel Bowl Site Glass



- Made of pure FKM and Viton® A-type material - NO fillers
- Can Run At 400°F Constant
  - Easy To Install, Conforms To Fuel Sight Bowl
  - Long Life Cycle Without Degrading
- Note: We Also Offer E8361381 Glass Bowl and E8104667 Clevis

### Head Seat Ring Technology



PowerRail Part #: E9581924PRD

- Enhanced Proprietary Viton® Compound
- Enhanced / Redesigned VPS Viton® profile for Ultimate Sealing
- Field Reports of reduced and/or elimination of “Engine Souping”

### B-SureSeal™ - Fuel Line Gasket

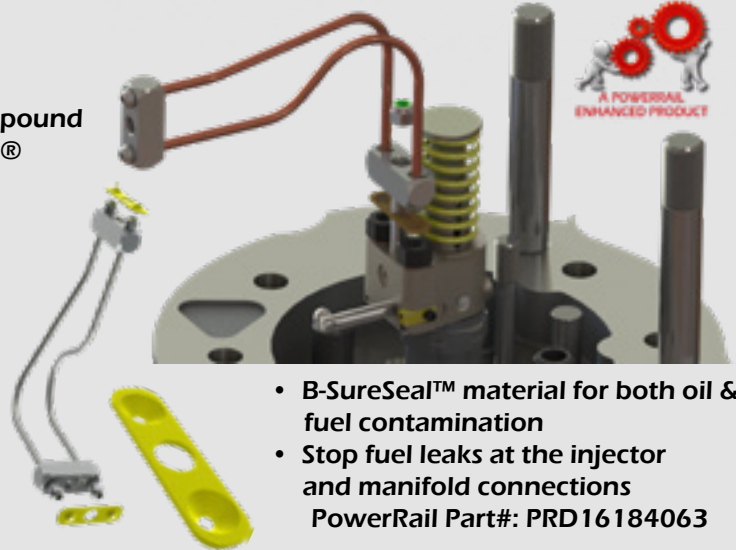

- B-SureSeal™ material for both oil & fuel contamination
  - Stop fuel leaks at the injector and manifold connections
- PowerRail Part#: PRD16184063

### Head to Liner Gasket

- Enhanced Grommet Design Will NOT Fall Out
- Teflon Silicone Hi Heat B-SureSeal™ Integral Grommet Design Utilizing Glass-Filled PTFE
- 410 Stainless for Improved Cycling Performance (Non Copper Plated to Eliminate Oil Contamination)
- Improved Compression Set Performance
- Improved Operating Temperature Range -50°F TO +460°F

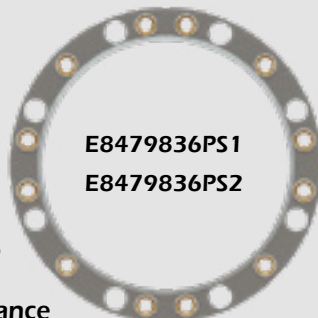

E8479836PS1  
E8479836PS2

### Water Elbow & Seal

Part# E40110618 Seal for E8414444 Elbow

- Stops Water Leaks Associated with Old Style O-Rings
- YellowSeal™ Material for both Oil & Fuel Contamination
- Class 1 Approved



## GASKETS & SEALS

### Enhanced Exhaust Stack Gasket

PowerRail P/N E40055466



- Class I Approved
- 21 Gauge Stainless Steel “Formed Bead Design”
- Opposing “Formed Beads” act as a spring mechanism in heavy thermal cycling applications
- High Temperature Graphite Sealing Element is designed to fill and seal surface imperfections commonly found on manifold and engine block surfaces
- Enhanced and Improved design will not be “crushed” or “beat-out” due to heavy vibration or harmonics, and resists unloading and bolt torque loss, as is common with the standard double jacketed design

## GAUGES - AIR FLOW INDICATORS FUEL AND AMMETERS

Complete Line of Air Flow Indicators,  
Fuel Gauges, & Ammeters



PowerRail P/N	Description
E10601196	Air Flow Indicator
E40017162	Air Flow Indicator
E8195741	Air Flow Indicator
E8387634	Air Flow Indicator, 60-160 lbs.
G84B104054P1	Air Flow Indicator
E10590743	Ammeter Load Indicator SD60
E40150894	Ammeter, Control Stand, SD40-E
E8214188	Ammeter TM 0-1500 AMPS
E8380058	Ammeter Traction Motor 0-1500AMP
E8438032	Ammeter Load Gauge 0-1500AMP
E8402426	Ammeter Traction Motor Load
E9573315	Ammeter Load Indicator
E10599378	Complex Gauge Assembly with AFM Indicator 4 1/2"
E8315266	Compressor Gauge, Float Type

## GAUGES

Complete Line of Dry and Liquid Filled Gauges



PowerRail P/N	Description
E40031338	2 1/2" 0-100 PSI Dry Gauge Oil
E8340547	2 1/2" 0-200 PSI Dry Gauge Air
E40018397	3 1/2" 0-160 PSI Dry Gauge Oil
E40018396	3 1/2" 0-200 PSI Dry Gauge Air
E8015552	3 1/2" 0-160 PSI Dry Gauge Air
E8032122	3 1/2" 0-100 PSI Dry Gauge Fuel Oil
E8032123	3 1/2" 0-100 PSI Dry Gauge Oil
E8037304	3 1/2" 0-160 PSI Dry Duplex Gauge Air
E8047964	3 1/2" 0-200 PSI Dry Duplex Gauge Air
E8231593	3 1/2" 0-200 PSI Dry Gauge Oil
E8231594	3 1/2" 0-160 PSI Dry Gauge Oil
E8380610	3 1/2" 0-200 PSI Dry Duplex Gauge Air
E8387352	3 1/2" 0-160 PSI Dry Duplex Gauge Air
G41A304641ABP1	4" 0-200 PSI Liquid Gauge Oil
G41B536099P3	4" 0-100 PSI Liquid Gauge Fuel
E8459294	4 1/2" 0-160 PSI Duplex Dry Gauge Air
E8481962	4 1/2" 0-160 PSI Dry Duplex Gauge
E8484326	3 - 4 1/2" 0-160 PSI Duplex Dry Gauge
E9080722	2 - 4 1/2" 0-160 PSI Dry Duplex Gauge
E9329370	4 1/2" 0-160 PSI Dry Duplex Gauge
E9540228	4 1/2" 0-160 PSI Duplex Dry Gauge Air

## Fuel Gauges

PowerRail P/N	Description
E9515153	Fuel Gauge Float Type 3,900 Gal
E9321144	Fuel Gauge Float Type 4,000 Gal
E8438327	Fuel Gauge Side Mounted 4,000 Gal
E40058437	Fuel Gauge Float Type 5,000 Gal SD70



**GEARS**

Complete Line of New Pinion Gears, Bull Gears & Traction Gears,  
as well as a complete line of High Quality Engine Gears

**Traction Gears & Pinions**

S. #	Bull Gear	PowerRail P/N
1	Gear - 65 tooth	E8178812
3	Gear - 63 tooth	E8402408
5	Gear - 62 tooth	E40049185 / E8109579
7	Gear - 61 tooth	E40049661 / E8184341
9	Gear - 60 tooth	E40049660 / E8179295
11	Gear - 59 tooth	E8184333
13	Gear - 58 tooth	E40049658 / E8184378
15	Gear - 57 tooth	E8184325 / E40049657
17	Gear - 56 tooth	E8184396
19	Gear - 55 tooth	E8184342
21	Gear - 52 tooth	E8184332
23	Gear - 63 tooth	E40051136 / E40051133
25	Gear - 62 tooth	E40051132
27	Gear - 60 tooth	
29	Gear - 58 tooth	E40051126
31	Gear - 57 tooth	E40051125
33	Gear - 70 tooth	E40012160
35	Gear - 69 tooth	E40049648
37	Gear - 67 tooth	E40049648
40	Gear - 66 tooth	E40049647

S. #	Pinion	PowerRail P/N
2	PINION Gear - 12 tooth D77	E8452310
4	PINION Gear - 14 tooth D77	E9556207
6	PINION Gear - 15 tooth D77	E40006705
8	PINION Gear - 16 tooth D77	E9556208
10	PINION Gear - 17 tooth D77	E9556209
12	PINION Gear - 18 tooth D77	E9556210
14	PINION Gear - 19 tooth D77	E9556211
16	PINION Gear - 20 tooth D77	E9556212
18	PINION Gear - 21 tooth D77	E9556213
20	PINION Gear - 22 tooth D77	E9556214
22	PINION Gear - 25 tooth D77	E9556215
24	PINION Gear - 14 tooth D31	E8179135
26	PINION Gear - 15 tooth D31	E8459295
28	PINION Gear - 17 tooth D31	E8206504
30	PINION Gear - 15 tooth D29	E8458508
32	PINION Gear - 16 tooth D29	E8341961
34	PINION Gear - 17 tooth D87	E40006706
36	PINION Gear - 18 tooth D87	E9332201
39	PINION Gear - 19 tooth D87	E9332202
41	PINION Gear - 20 tooth D87	E9332203

**Traction Gears & Pinions**

S. #	Bull Gear	PowerRail P/N
1	Gear - 90 tooth	G41C637598P1
3	Gear - 91 tooth	G8837760 / G41B530121P1
5	Gear - 92 tooth	G41C632784P2 / G8837724
7	Gear - 93 tooth	G41C636682P1 / G88377526P1
9	Gear - 94 tooth	G41C637211P1 / G8837727P1
1	Gear - 65 tooth	G41C635820P1
3	Gear - 74 tooth	G41C632494P1
5	Gear - 77 tooth	G41C632350P1
7	Gear - 83 tooth	G41C636806P1
9	Gear - 87 tooth	G41D735826P2
11	Gear - 90 tooth	G41C632381P1
13	Gear - 83 tooth	G41C637055P6

S. #	Pinion	PowerRail P/N
2	PINION 21 tooth	G41C637595P1
4	PINION 20 tooth	G84C614969P1
6	PINION 19 tooth	G41C632785P2
8	PINION 18 tooth	G41C635677P2 / G41C637903P1
10	PINION 17 tooth	G41C637180P1
2	PINION 18 tooth	G41C635796P1
4	PINION 18 tooth	G41C637399P1
6	PINION 26 tooth	G41C632349P1
8	PINION 20 tooth	G41C636447P6
10	PINION 16 tooth	G41D735825P1
12	PINION 17 tooth	G41C632382P1
14	PINION 20 tooth	G84C62083492

**Alt. Gears & Pinions**

S. #	Bull Gear	PowerRail P/N
1	Drive Gear 102T	G41C637055P6
3	Drive Gear 102T	G41C637055P6
5	Drive Gear 102T	G41C637055P6

S. #	Pinion	PowerRail P/N
2	PINION 43 Tooth	G41C635625P1
4	PINION 43 Tooth	G41C635800P1
6	PINION 43 Tooth	G41C632663P1

**Engine Gears**

S. #	Bull Gear	PowerRail P/N
1	Drive Gear 58T	E8483944
3	Drive Gear 58T	E8483945
5	Drive Gear 79T	E8360843
7	Drive Gear 113T	E8360839 / E8141909

S. #	Pinion	PowerRail P/N
2	Drive Gear 79T	E8069019
4	Drive Gear 79T	E8069014
6	Drive Gear 265T	E8416930

### GENERATORS - MAIN AND AUXILIARY

Complete Line of New & UX Main & Auxiliary Generators and Exciters

PowerRail P/N	Description	New	UX
E8405875	10Kw Aux Gen	Yes	Yes
E8405875MOD	14Kw Aux Gen	Yes	Yes
E8122750	18Kw DC Aux Gen	Yes	Yes
E4979844	18Kw AC Aux Gen	Yes	Yes
E9551383	18Kw AC Aux Gen	Yes	Yes
E9533149	18Kw AC Aux Gen	Yes	Yes
E3195473	24Kw AC Aux Gen	Yes	Yes
D12	Main Generator	No	Yes
D15	Main Generator	No	Yes
D22	Main Generator	No	Yes
D32B & D32P	Main Generator	No	Yes
D32E & D32E1	Main Generator	No	Yes
AR10	Main Alternator	No	Yes
AR11	Main Alternator	No	Yes
AR15 - AR17	Main Alternator	No	Yes
AR20	Main Alternator	No	Yes



**\*NEW AUX GENs  
IN STOCK!**

PowerRail P/N	Description	New	UX
GY27L2	Auxiliary Generator	No	Yes
GY27M2	Auxiliary Generator	No	Yes
581	Auxiliary Generator	No	Yes
586	Auxiliary Generator	No	Yes
598	Auxiliary Generator	No	Yes
GTA9	Main Alternator	No	Yes
GTA11	Main Alternator	No	Yes
GTA15	Main Alternator	No	Yes
GTA16	Main Alternator	No	Yes

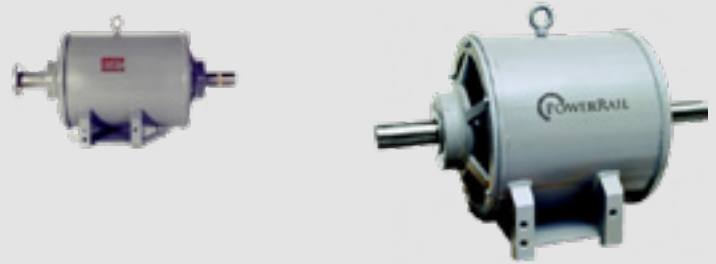

Full Line of Blower Wheels and  
Housing Assemblies also Available

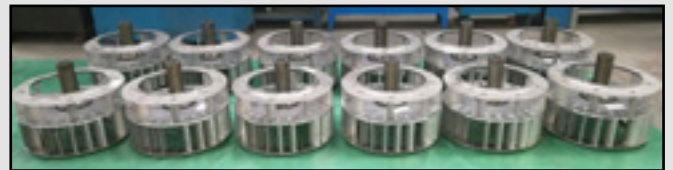

**GENERATOR DRIVE SHAFTS**

E8184471 - 5 7/8" OAL  
E8476944 - 15 5/8" OAL

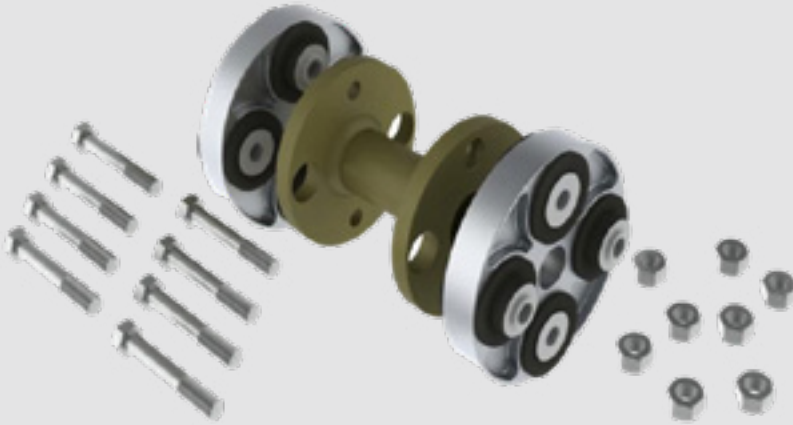

E8195996  
Coupling



E8234958 Compression Bushing  
or E16185106 Generator Bushing



**ADJUSTABLE AUXILIARY  
GENERATOR DRIVE SHAFT**

Now offering a simple solution for reducing inventory by utilizing an Adjustable Auxiliary Generator Drive Shaft.

Our adjustable shaft offers the same flange mounting with adjustments of 9.34" to 11.10"

**Part # PRD16186416**

Replace FIVE different drive shafts with just ONE.

- E8227020 Drive Shaft 9.344"
- E9509579 Drive Shaft 9.625"
- E8253884 Drive Shaft 9.875"
- 10604516 Drive Shaft 9.969"
- E8227021 Drive Shaft 11.094"



### HANDRAIL - CARBODY

Complete Line of New Handrails and  
Related Deck Products



See Page 97 for Related Parts

### HEAT SHIELDS

Complete Line Of Heat Shields



PowerRail P/N	Application
E40089234	SD70 Right Rear
E40089235	SD70 Left Rear
E40089236	SD70 Right and Left Front
E40089237	SD70 Right and Left Front
E40089238	SD70 Left Front and Right Rear
E40109698	SD70 Z Type
E8351251	Intermediate Rear Left Hand
E8351254	SD70 Right and Left Front
E8358827	Rear Left Hand

### HEATERS

Complete Line of Heaters including Free Standing, Wall Mounted and Sidewall.

PowerRail P/N	Description	Comments
P5006B Series	Free Standing	3000W - 3750W - 4000W
E40012336	Free Standing Stock Model	3000 Watt with Top Defrost With Sidewall Circuit Panel
E40001549	Free Standing Stock Model	3000 Watt with Top Defrost NO Circuit Panel
PM5032	Wall Mounted	3000W - 3750W - 4000W
PM5002	Sidewall	Dual 660W & 1320W
PM5002-2	Sidewall Stock Model	Dual 750W & 1500W
PM5029	Control Switch	Dual Per Above
P24477	Circuit Breaker	65A 3 Pole
P21366	Heater Motor	5/16" Dia. Single Shaft
P21134	Heater Motor	5/8" Dia. Single Shaft
P20605-1	Heater Motor	5/16" Dia. Dual Shaft
P21159	Heater Motor	5/16" Dia. Dual Shaft
P24442-1	Heater Brush	2 per Set
P31118	Junction Box	Wall Heater
P31005	3 Position Switch	Junction Box

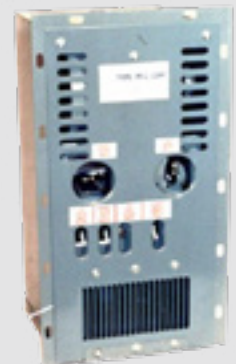



## HEAT EXCHANGERS

### RADIATORS, OIL COOLERS, PREHEATERS, INTERCOOLERS AND AFTER-COOLERS

Complete Line of New and Unit Exchange Heat Exchangers

- ISO certified and Caterpillar Bronze Certified
- Tier 1 EPA Certified Products
- Custom Design and Manufacturing Strengths
- Extended Warranty

PowerRail P/N	Description
E40036275	Single 6 Row
E40017114	Triple 6 Row
E40017115	Double 6 Row
D4MB	Double 4 Row
T4MB	Triple 4 Row
S8MB	Single 8 Row
D8MB	Double 8 Row
T8MB	Triple 8 Row
Quad8	Quad 8 Row
G41D711033G10	31" Radiator No Tanks
G41D701689P2	31" Radiator With Tanks
G41D712040G4	42" Radiator No Tanks
G41R971400G9	42" Radiator With Tanks



PowerRail P/N	Description
E9544027	SW1500 Bundle Tubes
E9339040	4" MB Oil Cooler Core
E8364030	4" MB Oil Cooler Core WITH Case
E9514842	6" MB Oil Cooler Core
E9558515	6" MB Oil Cooler Core WITH Case
E9577200	Preheater - Standard GP Style 60K
E40057079	Preheater 60K BTU SD70
G84D702217P1	Preheater
E8288974	10 Row After-Cooler 2 Pass 2 Flange
E8409891	10 Row After-Cooler 2 Pass 2 Flange
E40020885	12 Row After-Cooler 4 Pass 2 Flange
E40113591	12 Row After-Cooler 4 Pass 4 Flange
G128X1649	Intercooler Right - Long
G128X1650	Intercooler Left - Long
G128X1692	Intercooler Right - Short
G128X1693	Intercooler - Left Short
E9087321	Radiator Cap 2 Prong
E9323490	Radiator Cap 3 Prong
E9338780	Rad Cap 3 Prong 20PSI
E8039994	2 5/8" X 8" Rad Hose

**EMERGENCY**

**E8386654 Emergency Leak Stopper**  
0.75OZ Containers in Stock



**PRD16184458 Coolant Test Kit**  
Rust Inhibitor



Mechanical Bonding Heads



Mechanical Head Completed



Pressure & Leak Tested -  
Quality is #1

**HOSES - AIR**

New line of AAR Air Hose and other related Air Brake components

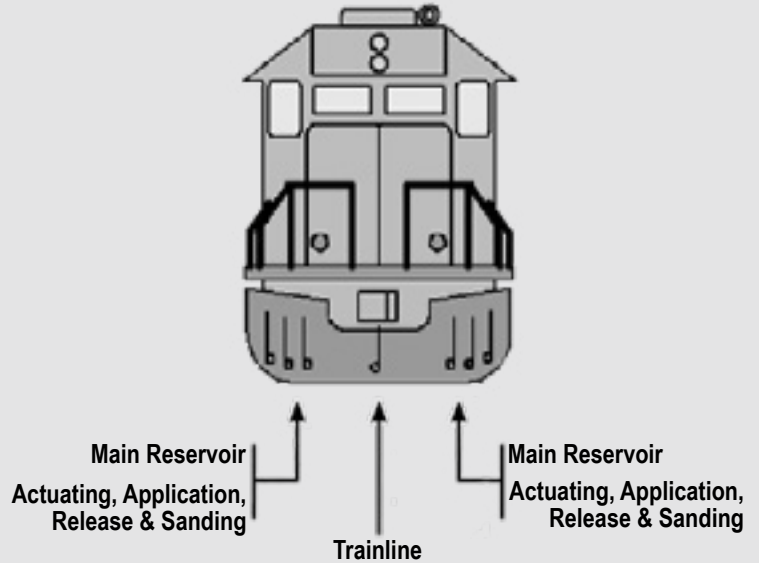
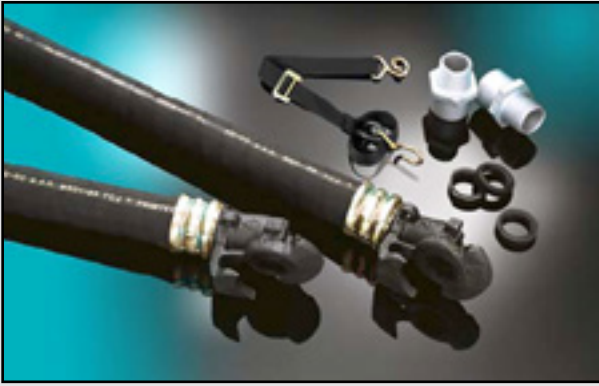

**Actuating Application & Release 1/2" Male NPT  
AAR M-618 LS4 Gladhand**

PowerRail P/N	Overall Length	Hose Size
HAL5880	34"	3/4 (1/2)
HAL5217	36 1/8"	3/4 (1/2)

Note: Above are Common Hoses. We offer a full line from 25" to 36" OAL

**Train Line 1 3/8" Hose 1 1/4" Male NPT  
AAR M-601 FP5 Gladhand**

PowerRail P/N	Overall Length	Hose Size
HFR12422	22"	1 3/8"
HFR12433	33"	1 3/8"

**Main Reservoir 1" Male NPT  
AAR M-618 LS4 Gladhand**

PowerRail P/N	Overall Length	Hose Size
MRL5064	34"	1 1/8"
MRL5209	35"	1 1/8"
MRL5640	36 3/16"	1 1/8"

Note: Above are Common Hoses. We offer a full line from 25" to 43"

**1 1/4" MALE PIPE THREAD x 1 1/4"  
MALE PIPE THREAD - AAR M-601**



PowerRail P/N	Overall Length	Hose Size
N777733	26 1/8"	1 1/8"
N779362	27"	1 1/8"
N777583	28 1/8"	1 1/8"
N777734	37 1/8"	1 1/8"
N777866	59 1/8"	1 1/8"

**Don't Forget the Gasket!**  
Part # W563952  
FS5 Gasket



**DUMMY HOSES & COUPLINGS**



PowerRail P/N	Overall Length	Hose Size
N777356	12 5/8"	1 1/8"
N777355	15 1/8"	1 1/8"
N777357	16 5/8"	1 1/8"
N777358	17 5/8"	1 1/8"
N777889	27 5/8"	1 1/8"



PowerRail P/N	Type	Vent Holes	Chain Length
N703123	H-3	Yes	7 1/2"
N756979	H-3	Yes	14"

**ENGINE RELATED FUEL, OIL & AIR HOSES**

PowerRail P/N	Application
E9320120	Detector to Water Pump
E9320121	Detector to Water Pump
E9320122	Detector to Water Crankcase
E9319341	Governor Oil Drain
E9319342	Lube Oil
E8155981	Wiper
G140X2954	Low Pressure Fuel
G140X1553	Turbo Oil Feed
G140X2935	Oil Drain



**FREIGHT CAR & SPECIALTY HOSES**

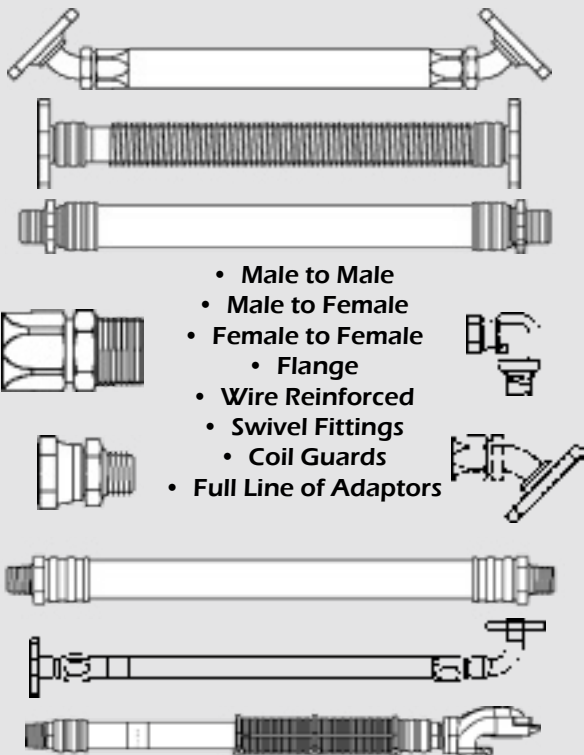

- Male to Male
- Male to Female
- Female to Female
  - Flange
- Wire Reinforced
- Swivel Fittings
  - Coil Guards
- Full Line of Adaptors

**Run-A-Round Hose - Part # 16186897**



- Get a train moving again within 15 minutes of identifying the crippled car
- No need to move the crippled car to a siding
- Can be installed by 1 person without tools
- For use on cars up to 89' in length (multiple units can be connected)
- Weight: 18.5 lbs.
- Overall diameter: 19.5"

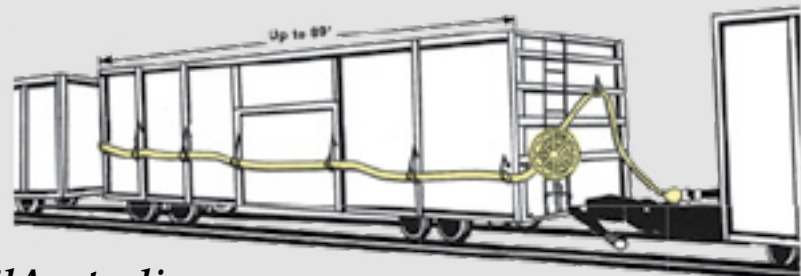

### HOSE - KITS

Full line of Special Kits that can be customized to any requirement

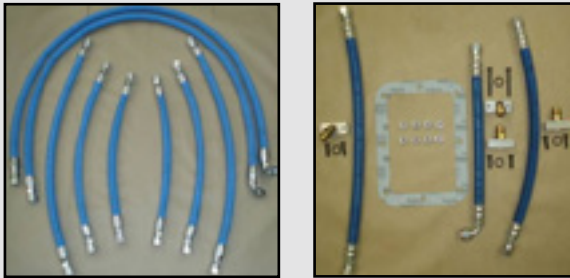

### HOSE - SAND

“Safe Sand” Gold Series

New Generation Utilizing Cloth Weave Technology Eliminating Wire Related Injuries



PowerRail P/N	Description	Hose Size
E8328950	50 Ft. Roll Sand Hose	1 5/16
E9097530	25 Ft. Roll Sand Hose	1 5/16

See Page 65 for All Sand Related Items

### HOSE STRAP

AAR 4006 High Strength Synthetic Strap



PowerRail Part# NY778117

### HOUSINGS

Complete Line of Ditch, Headlight, Step Light , MU Housings and Receptacles.

PowerRail P/N	Application
E8650814	Ditch Light Housing
E40043668	Ditch Light
G41B549606P1	Ditch Light
E8235852	Headlight Vertical & Horizontal Mount
E8332339	Headlight Vertical Mount With shield
E40046500	Headlight Dual SD70
E8382662	Contact MU
E8079302	Cover - MU Receptacle
E9572733	MU Dummy Receptacle
G84A201176P3	MU Dummy Receptacle with back plate
E8242444	MU Receptacle Complete Assembly - 27 Pin
E8004092	Step Light Assembly
G41A200358P1	Step Light Assembly
E10590984	Step Light Assembly
E10605432	FRA Red Lens Light Assembly
G41A205337ABP2	Light Assembly Clear Lens
E40016750	Brake Light Indicator
8351700	MU Receptacle - No Contact Pins



### Universal Ditch Light Housing

PowerRail PRD16184911

- E8650814 / E40043668 - 2 Position Door Latch Flush Mount
- E40052369 / E40069142 - 4 Position Door Latch Flush Mount

Benefits:

- Dual Mount - Flush or Conduit from Bottom (2) 1/4" NPT Mounts
- High Temperature Silicone E10610987 Gasket Included
- (4) Four Position Door Latch
- Reduction in Inventory
- High Quality Casting



Also offering Ditch Light Housing G41B549606P1, G41B549606P3, and Ditch Light Assembly E6911151

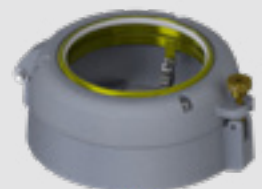

## INSULATION TESTERS

Complete Offering of Electrical and Electric Measuring Equipment

### Improved 5 and 10kV insulation testers

- Smaller size and lighter weight
- Easier to use
- Rotary switch dial
- Unique dual case design
- Intuitive operation
- Ramp test
- 3mA output power
- Accuracy where it matters most
- Super fast battery charge

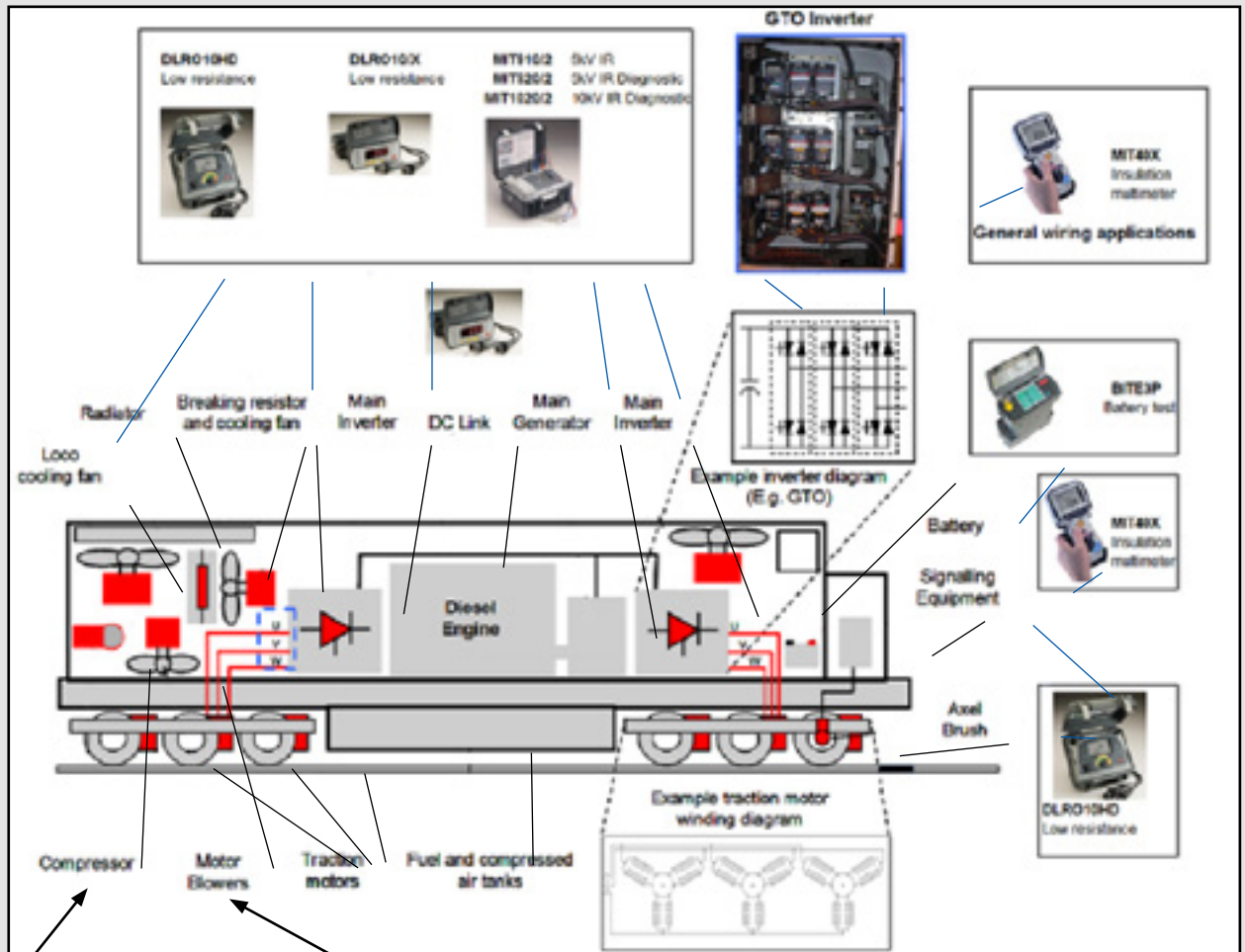

**JOURNAL BOXES - HYATT & ROLLER WHEEL BEARINGS**

Complete Line of AAR Quality New and Remanufactured Hyatt Journal Boxes, Conversion Boxes and Tapered Bearings

**\*We Offer Unit Exchange or R&R Programs\***



Hyatt W/3N1 Liner

PowerRail P/N	Application
E7476217	Hyatt Journal Box 6½ x 11
E7476218	Hyatt Journal Box 6½ x 12 Standard 3N1 Liner
E7476218-3PC	Hyatt Journal Box 6½ x 12 3-Piece Lug Liner
E7476218MOD	6½ x 12 Modified for GG Bearing

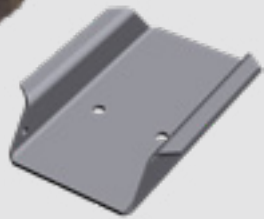

All Hyatt Boxes are Modified with the 3N1 Liner Standard



Hyatt & Conversion Box Lateral Pad  
E9539431 & PRD16184305

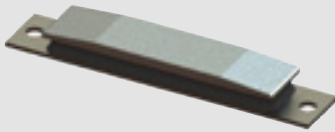

E9539431 Lateral Pad

E9539431 Lateral Pad for all Hyatt and Generic Conversion Boxes for Locomotive axle.  
PRD16184305 Manufactured 1/8" lower to ease installation due to restraints and tight fits.

**\*Offering a Full Line of Modified Boxes\***

New and Unit Exchange GG Style Boxes	
E9539650	GG Adaptor Box (9580195)
E9539431	Lateral Pad
PRD16184305	Lateral Pad 1/8" Undersize
G41D7277667G5	GG Adaptor Box



**JOURNAL BOXES - HYATT & ROLLER WHEEL BEARINGS**

Complete Line of AAR Quality New and Remanufactured Hyatt Journal Boxes,  
Conversion Boxes and Tapered Bearings

PowerRail P/N	Description
E7482827	Cover w/ Pipe Plug
E7491289	Cover with Axle Gen Hole
E8148707	Adaptor Extension for Axle Generator
E9529931	Bracket Shock Lower
E9529903	Bracket Shock 3 Axle



**E7491289**

**E8148707**



**112192**



**E9529931**



**E9529903**



**Fig A**



**Fig B**

Journal Box Shims			
PowerRail P/N	Description	PowerRail P/N	Description
E8455980 (Fig A)	1/8 Inch	E8455982 (Fig B)	1 Inch
E8177292 (Fig A)	3/8 Inch	E8112192 (Fig B)	1 1/4 Inch
E8455981 (Fig B)	1/2 Inch	E8455983 (Fig B)	1 1/2 Inch
E8044686 (Fig B)	3/4 Inch	E8223384 (Fig B)	1 3/4 Inch

**Full Line of Remanufactured Locomotive & Freight Bearings**



Type	Size	Capacity - Tons
D	5 1/2 x 10	50 - Passenger
E	6 x 11	70 - Passenger
F	6 1/2 x 12	100 - Passenger
G	7 x 12	125
EE	5 1/2 or 6	Passenger
GG	6 1/2 or 6 3/4	Locomotive



## **LOAD BOXES**

Complete Line of Custom-made Load Boxes

### **Custom Load Boxes**

Together, PowerRail Locomotive Services & PowerRail Electronics create complete custom-made Load Boxes to fit your needs. We offer New or Remanufactured Fans and Grids, as well as custom paint to fit the color scheme of your railroad.

- 2,000HP Load Box with (4) grids and (1) 36hp fan
- 3,000HP Load Box with (6) grids and (2) 18hp fans
- 4,000HP Load Box with (8) grids and (2) 18hp fans





**MODULES**

Complete Line of Electronic  
Modules, Cards and Panels



Type	Description
AN17	Annunciator
DE12	Dynamic Brake Ext. Range Control
DG12	Dynamic Brake Grid Protection
DP12	Dynamic Brake Protection
DR20	Dynamic Brake Regulator
EL11	Excitation Limit Control
GV12	Generator Volt Regulator
GX12	Generator Excitation Regulator
PF17	Performance Control
PF29	Performance Control
RC12	Rate Control
SA10	Sand Control
SB11	Sensor By-Pass Max Performance
SE13	Sensor
TH14	Throttle Resp & Volt Reference
TR12	Transition Control
VR14	Voltage Regulator
WS10	Wheel Slip

**NAME PLATE & NUMBERING**

Complete Line of Nameplates, Locomotive  
Numbers & Signs of All Shapes & construction



**G17FD and G17FL Style - Blue Electronic  
Cards Regulators and Complete Aux Panels**



Sign Description	Sign Size	PowerRail P/N
Engine Water Drain Inside	3 x 9	PP50035-131
Emergency Brake Valve	4 3/8 x 8 3/8	PP50035-59
Engine Water Fill	4 3/8 x 8 3/8	PP50035-6
Emergency Fuel Cut-Out	2 1/2 x 6	PP50035-61
Danger 600 Volt	4 3/8 x 8 3/8	PP50035-67
Emergency First Aid Kit	5 x 11	PP50035-7
Fire Extinguisher Inside	6 x 12	PP50035-72
Sanitary Drain Pipe	4 7/8 x 9 1/8	PP50035-9

We will Custom Manufacture Any Sign

### PIPE CLAMP BRACKETS

Complete Line of Pipe Clamp Brackets

PowerRail P/N	Pipe O.D.	Length	Pipe or Tube
E8108110	¼"	2 ½"	Tube
E8108299	¼"	4"	Tube
E8108111	⅜"	2 ½"	Tube
E8108118	⅜"	4 ½"	Pipe
E8108202	⅜"	4 ⅝"	Tube
E8108113	½"	2 ½"	Tube
E8108115	½"	3"	Pipe
E8108116	½"	3"	Pipe
E9329413	½"	3"	Pipe
E8108125	½"	3"	Pipe
E8108117	½"	3 ⅞"	Pipe
E8108206	½"	4"	Tube
E8104470	½"	4"	Pipe
E8108114	⅝"	2 ¾"	Tube
E8108209	⅝"	4 ½"	Tube
E8108126	¾"	3 ¼"	Pipe
E8327561	1"	3 ½"	Pipe
E8108127	1"	3 ½"	Pipe
E8108129	1 ½"	4 ⅜"	Pipe



PowerRail P/N	Pipe O.D.	Length	Pipe or Tube
E8108201	¼"	8 ¼"	Tube
E8108118	⅜"	4 ½"	Pipe
E8108202	⅜"	4 ⅝"	Tube
E9318029	⅜"	5 ⅞"	Tube
E8236518	⅜"	6 ⅝"	Tube
E8236518	⅜"	6 ⅝"	Tube
E8108197	½"	6 ⅝"	Pipe
E8108208	½"	8 ⅜"	Tube
E8155268	½"	8 ⅝"	Pipe
E8108209	⅝"	4 ½"	Tube
E8108211	⅝"	8 ⅞"	Tube
E8108214	¾"	8 ¾"	Tube
E8108217	1"	8"	Pipe
E8108219	1 ¼"	4 ½"	Pipe
E8108129	1 ½"	4 ⅜"	Pipe
E8108241	2 ½"	7 ⅝"	Pipe

**PINS - BUSHINGS - SLEEVES  
CLEVIS - LINERS, ETC.**



**For a Complete List - See Page 96 for QR Code**



### RESISTOR GRIDS

Complete Line of Braking Resistor Grids.

PowerRail P/N	Resistance
E8304194, E40085144	.927 Ohms
E8304193, E40085145	.860 Ohms
E8347464, E40085146	.922 Ohms
E8339532	1.072 Ohms
E8339533	.970 Ohms
E9337613	.642 Ohms
E9337614	.689 Ohms
E9331050, E9191050	.923 Ohms
E9331051	860 Ohms
E8185703, E40085141	.660 Ohms
E8185704, E40085142	.660 Ohms
E8185705, E40085143	.690 Ohms
E8190834	.690 Ohms



PowerRail P/N	Resistance
E40010556	.860 Ohms
E40010557	.860 Ohms
E40010558	965 Ohms
E40010559	.632 Ohms
E40010560	.766 Ohm



**\*Please Contact Us On Our  
GE-Style Grids**

### SAND NOZZLES

Complete Line of Sand Nozzles

PowerRail P/N	Description	Application
E8328553	Sanding Nozzle	EMD Style
E8328938	Sanding Nozzle	EMD Style
G84C615855P1	Sanding Nozzle	GE Style
G41C625615P1	Sanding Nozzle	GE Style
G41B545256P1	Sanding Nozzle	GE Style



### SAND RELATED

Complete Line of Sand Related Support Items

PowerRail P/N	Sand Valves
E8320347	Shut-Off No Flange
E8320349	Shut Off With Flange
E9097530	Sand Hose 25 Foot
E8328950	Sand Hose 50 Foot
E8374760	Sand Hose Clamp
E8348109	Sand Trap 1 ¼ Inch
E8498335	Sand Valve Relay



PowerRail P/N	Description	Application
E8355568	Universal Guide Left	EMD & GE
E8355569	Universal Guide Right	EMD & GE
E8133933	Sand Pipe Guide	Left Front
E8133932	Sand Pipe Guide	Right Front
E8269587	Sand Trap	EMD Style
E8349902	Sand Trap	EMD Style
E8350356	Sand Trap	EMD Style
E10539205	Sander Guide Assembly	EMD Style

**\*Special Designs Available if Required**

**SAFETY LINE**

Complete Line of Safety Products



**SAFETY - PERSONAL USE**

**First Aid Kit**

First Aid Kit For Any On-board  
Accidents and Injuries  
PowerRail P/N 16184888



**Hearing Protection**

Premium Hearing Protection

- Innovative Flexible Bands offers Better Fit & Greater Comfort
- Optimal Band Size “One Size Fits All”
- Optimal Fit & Hearing Protection with 3 sets of Buds for precise Ear fits
- Durable Construction for Durability and Contamination Resistant



**Safety Vests**

Manufactured for Rail Industry Safety



- ANSI/ISEA 1007-2004 Class 2 Certified
- 5 Point Tear Away for Snagging Safety
  - 100% Flame Resistant
  - 3M Reflective Strips
  - Washable

\*5 Velcro points on vest allows for easy removal. Tear-away points on each shoulder, each side, and in the center.

**Work Gloves**

Complete Line of Work Gloves for Any Application and Protection



**Rubber**

**Leather**

**Mechanics**

**SAFETY - FACILITIES**

**Cones**

Exclusively Manufactured to Meet Rail Requirements



Lime or Orange  
Plain - No Stripe  
3M - One Stripe  
3M - Dual Stripe

18" with 3 lb Base  
28" with 7 lb Base  
36" with 10 lb Base

**Drain Mat**

Seals drains, grates, sewer, etc. against fuel and chemical spills. Durable and impact resistant  
100% Polyurethane.



36" x 36" x 1/2"  
Standard Size

Custom Sizes & Rolls Available



Also available,  
Emergency Spill Kits

Rail Version 3 1/4 lb, light-weight for rapid response and ease of use.

**FRA-224 Reflective Tape**

Complete Line of 3M® FRA Tape

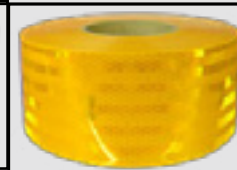

- 4" x 150 Foot Rolls
- Kiss Cut or Continuous Roll
- White - Yellow - Fluorescent Yellow Colors



**SAFETY LINE**

Complete Line of Track Mats and Pad



**Track Mat - Coldform 2**

- **PRD16185004-19**
  - 19" x 100' for outside of track
  - 1 case = 2 rolls per case
- **PRD16185004-57**
  - 57" x 100' for inside of track
  - 1 case = 1 roll per case
- **PRD16185004-SET**
  - 1 case of both sizes

**Sorbent Socks**

**Maintenance & Oil Only**



- **PRD16185036-O**
  - 3" Diameter x 4' Length
  - 30 socks per case
  - WHITE - Absorbs Oil ONLY
- **PRD16185036-WO**
  - 3" Diameter x 4' Length
  - 30 socks per case
  - GREY - Absorbs Oil & Water

**Sorbent Pads and Rolls**  
**Oil-Only Medium Weight**



- **PRD16185035-PAD**
  - 15" x 18" pad
  - 100 pads per case
  - WHITE - Absorbs Oil ONLY
- **PRD16185035-ROLL**
  - 30" x 150 roll
  - WHITE - Absorbs Oil ONLY

**Sorbent Pads and Rolls**  
**Maintenance Med. Weight**



- **PRD16185034-PAD**
  - 15" x 18" pad
  - 100 pads per case
  - GREY - Absorbs Oil & Water
- **PRD16185034-ROLL**
  - 30" x 150 roll
  - GREY - Absorbs Oil & Water

**SAFETY STARTER SLING**

Our Starter Safety Sling is designed to help make replacement of locomotive starters both a SAFE and EFFICIENT process

**Starter Safety Sling Features**

400lb Weight Capacity  
Heat Resistant Up To 360° F & Chemical Resistant  
X-Pattern Stitching For Extra Reinforcement  
Safety Yellow Material  
Our sling can be used on all 32 and 64 volt starters

**Part #: PRD16184407**



**Lift Safely**



**Install Safely**



**Release Safely**

**SAFETY LINE**

Complete Line of Aluminum Safety Treads

**Facility Safety**

Safety Solution for Worn out Stairs. Aluminum Treads Installed Over Damaged or Unsecured Steps



**Before**

**After**

**Locomotive Safety**

Aluminum Safety Treads Designed Exclusively for Injury Prevention on a Locomotive

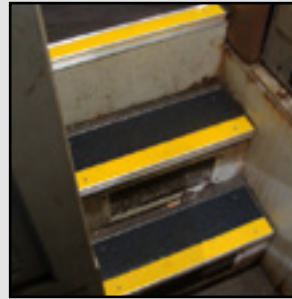

**SD70AC Cab Steps**

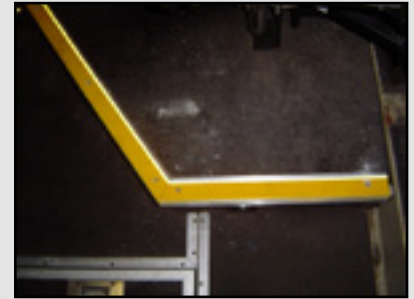

**SD70AC Engineer Side**

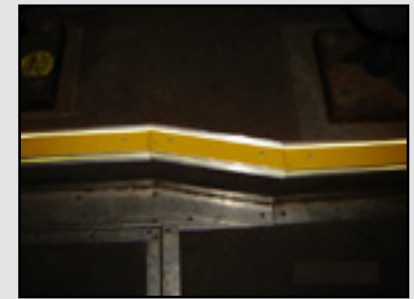

**SD70AC Conductor Side**

**DESIGNED AS KITS**

**Solution Provided**

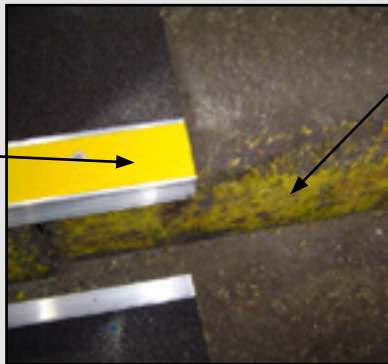

**Damaged Concrete Step**

**Custom Made for ANY Size Step**

**Other Sure-Foot Products**  
 Safety Adhesive-Back Tread Signs

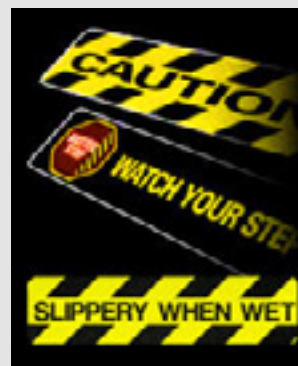

Custom Made for Any Locomotive Pit  
 Up to 10' Length

**ANY WIDTH**

Visually Enhances Dangerous Areas



### SEATS - ROAD UNITS

Complete Line of Seats for Road Units

- Rugged heavy-gauge tubular steel
- 2-way adjustable lumbar support
- Infinitely adjustable backrest angle
- Cushion rake angle adjustment
- 2" forward adjustment on seat cushion
- 9" fore-and-aft seat adjustment
- Fire-resistant Vinyl Material (Cloth Optional)
- Full foam bolsters with contoured lumbar support
- Integral spring supported cushion for shock isolation
- ABS plastic back protector w/ placard attached



PowerRail P/N	Application
P180109CD37	High Back Non Sleeper
P176025PS	Floor Mount 4" Height Adjustment
P178241PS	Wall Mount With Swivel 3" Height

### SEATS - SWITCHERS

Complete Line of Seats for Switchers

- Narrower, shorter seat for Switcher applications
- Rugged heavy-gauge tubular steel construction
- Infinitely adjustable backrest angle
- 2-way adjustable lumbar support
- Fire-resistant black vinyl material
- Full foam bolsters w/ contoured lumbar support
- Integral spring supported cushion for shock isolation
- 6" fore-and-aft seat adjustment



PowerRail P/N	Application
P183049CD37	Switcher Mid Back Standard
P183049CD37ARM	Switcher Mid Back With Arm
P180837	Ultra Low Back
P180837ARM	Ultra Low Back With Arm

### SHIMS AND SPACERS

Complete Line of Shims and Spacers



PowerRail P/N	Description
G41A210731P4	.062" Shim Air Compressor
E8478477	Shim Axle Cap
E40014450	.031" Shim Bearing Flange For Combo's
E8061581	.015" Shim Bearing to Bracket
E8083559	.020" Shim Bearing Plate
E8156922	Shim 11 Gauge
E8159285	.063" Main Generator Mounting
E8159286	.125" Generator Mounting
E8178082	.004" Shim Roots Blower
E8194923	.625" Frame Cover and Support
E8348671	.014" AR10 Shim
E8478477	.010" Shim Axle Cap
E8348667	AR10 11 Gauge
E8348668	AR10 16 Gauge
E8348669	AR10 20 Gauge
E8348670	AR10 24 Gauge
E8348671	AR10 0.14"
E8348672	AR10 .005"



### SNOW PLOW

“PowerBlade” manufactured by PowerRail.  
Universal Design fits most Locomotives

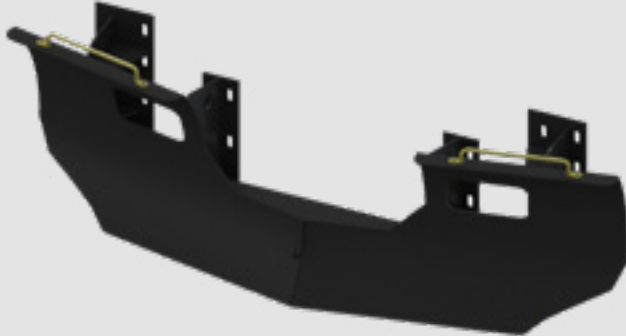

**100% Made in the USA**

### SNUBBERS - SHOCK ABSORBERS - DAMPERS

Complete Line of Shock Absorbers and Snubbers



**Common Stock Items**

PowerRail P/N	Description
E4974695	Shock Lateral
E4993721	Shock
E40020355	Damper Yaw
E40031527/40087597	Shock Combo End
E40122566	Damper
E40086732	Damper
E40088065	Damper Yaw
E40153054	Damper Vertical
E40153061	Snubber
E40153062/22012514	Shock
G41A244100AAP	Snubber
G41C624176P1	Snubber
G41A319100P	Damper Axle
G41A319101P	Damper Lateral
G41A319102P	Damper Vertical

### SPARK ARRESTORS

Complete Line of Spark Arrestors For Any Locomotive. Custom or Standard Design



**Locomotive Spark Arrestors**

PowerRail P/N	Application	Qty Required
10AC8	EMD SW-1	1
10AC10	EMD NW-2	2
10AC10	EMD NW-5	2
10AC12	EMD SW-8	1
10AC10	EMD SW7/9	2
10AC12LP	EMD SW-900	1
10AC12LP	EMD SW-1200	2
12AC12LP	EMD SD-7	2
12AC12LP	EMD SD-9	2
12AC12LP	EMD E-7	2
12AC12LP	EMD E-8	2
12AC12LP	EMD E-9	2
12AC12LP	EMD GP7	2
12AC12LP	EMD GP9	2
10AC10	EMD GP10	4
12AC12LP	EMD GP18	2
12AC12LP	EMD GP28	2
12AC12LP	EMD GP38	2



**STARTER MOTORS**

Complete Line of New and Unit Exchange Starter Motors

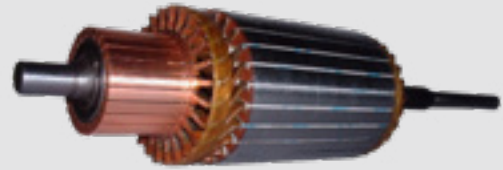
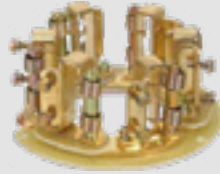
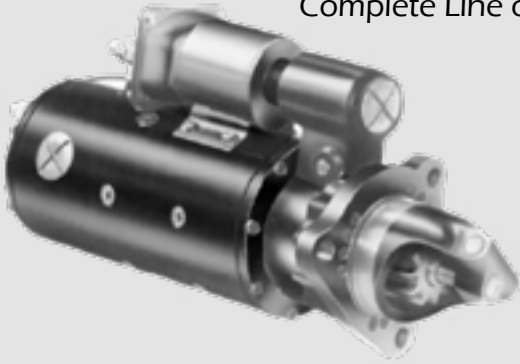

**Other Starters are Failing Prematurely  
Due to the AESS Application**

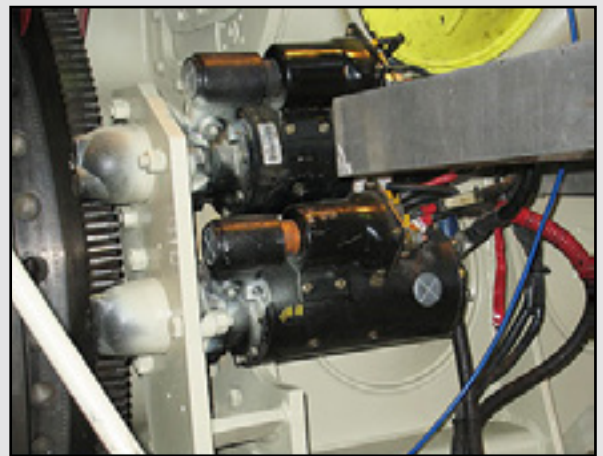

PowerRail P/N	Description
E8384834/E1990333	32 Volt Starter
E8384834/E1990333AESS	32 Volt AESS*
E8428605/E1993740	64 Volt Starter
E8428605/E1993740AESS	64 Volt AESS*
E10478827/E40069492AESS	32 Volt AESS SD70 Series
*Also available as Unit Exchange	



The **UNIQUE** Austart Air Starters are proven in Rail, Marine, Mining, Power Generation, Drilling and Gas Compression markets with great results holding up under the most demanding environments.



Call us for our Full Line of Air Starters  
New OEM Style, Light weight  
Low Air consumption.

**Benefits of Our AESS Starter:**

- Modified Single Brushholder Design
- Special Oversized Heavy Duty Brush replaces OEM 2 brush per box design
- Modified Heavy Duty Solenoid
- Modified Armature with increased Amperage Capacity and Heat Transfer



**E8358874  
Starter Bracket**



**E8387359PRD  
Starter Cover**  
Ask about our Enhanced Starter Shield

## SWITCHES

Complete Line of New and Unit Exchange Pressure, Temperature and Slide Switches,  
as well as Sensors, Transducers and Valves

PowerRail P/N	Description
E8296748	Switch Roller Button 1NC - Throttle - Single End Faston Connection
E8296750	Switch Slide Roller Button - Controller Mechanism - Single End Faston
E8296752	Switch Roller Button 1NC - Controller Mechanism - Single End Faston
E8330133	Slide Switch Button Generator Field 1 NO with Double End Faston
E8330137	Slide Switch NO - Lights Engine Room, HV Cab Walkway
E8455355	Slide Switch 2 NO - Ditch Light With Seal Wire
E9097525	Slide Switch - 1 NO and 1 NC with Single End Faston Tab - Start, Head Light
E8481166	Slide Switch - 1 NO with Double End Faston Tab Connections - Light
E9333939	Slide Switch - 2 NO - Fuel Pump - With Double End Faston Tab Connections
E9096836	Rocker Switch-Double Pole, Single Throw
E8299162	Roller Switch-Manual Roller Lever 10A 120VDC
E8117872	Pressure Switch-Open at 20lbs, Closed at 35lbs.
E8301186	Pressure Switch—Cut in 130PSI, Cut Out 140PSI
E8334998	Pressure Switch-Cut in 10 PSI, Cut Out 15 PSI
E8340775	Pressure Switch-Open at 40lbs, Closed at 20lbs
E8425022	Pressure Switch-1st Stage, Open at 130PSI, Closed at 140 PSI 2nd Stage-Open at 135 PSI, Closed at 145 PSI.
E8425056	Pressure Switch-3 Pole Receptacle
E8283936	Temperature Switch—In at 170°, Out at 155°
E8424290	Temperature Switch-In at 174°, Out at 159°
E8425575	Temperature Switch-In at 215°, Out at 205°
E8457270	Temperature Switch-In at 175°, Out at 160°
E8457492	Temperature Switch-In at 185°, Out at 170°
G41A212103P1	Toggle Switch-3 Pole Double Throw 15A
E8004701	Toggle Switch-Toggle SPST 20A
E8140767	Toggle Switch-2 Position 10A, 250 Volt
E8150199	Toggle Switch-Toggle Fan Cab DPST
E8316637	Toggle Switch-3 Pole, Double Throw, 2 Position
E8373198	Toggle Switch-3 Pole, Single Throw, 10A-250V Ground Relay
G41B510557P13	Pressure Switch—Independent Brake 1-75 PSI

**\*The above list is only a sample of the various switches that we offer.  
Please contact Customer Service for more options.**



**SWITCHES - ROTARY**

Complete Line of Rotary Switches

<b>PowerRail P/N</b>	<b>Description</b>
E8204906	Cab Heater 4 Position 1 Pole 10A 125V
E8351224	Cab Heater 4 Position 1 Pole 10A 125V
E8276486	Cab Heater 4 Position 3 Pole 10A 125V
E8238108	Signal Light 4 Position 8 Pole 10 Amp 125 V.A.C.
E8314947	Sequence Test Panel 2 Position 8 Pole 10 Amp 125 V.A.C.
E8272931	Sequence Test Panel 3 Position 5 Pole 10 Amp 125 V.A.C.
E8440928	Module Test Panel 3 Position 5 Pole 20 Amp 600 V
E8332070	Fuel Prime and Engine Start 3 Position 4 Pole 10 Amp 125 V.A.C.
E8346425	Fuel Prime and Engine Start 3 Position 5 Pole 10 Amp 125 VAC
E8441983	Fuel Prime and Engine Start 3 Position 6 Pole 20 Amp 600 V
E8242197	Headlight 2 Position 4 Pole 30 Amp 250 V.A.C
E8277638	A,C, Terminal Light 2 Position 2 Pole 30 Amp 250 V.A.C.
E8287557	Signal Light 2 Position 5 Pole 30 Amp 250 V.A.C
E8238109	Remote Head Light 4 Position 4 Pole 30 Amp 250 V.A.C
E8370683	Manual Power Red 3 Position 3 Pole 10 Amp 125 V.A.C.
E8345702	Traction Motor Cut-Out Switch 4 Position 10 Amp 125 V.D.C.
E8336232	Traction Motor Cut-Out Switch 5 Position 10 Amp 125 V.D.C
E8348980	Traction Motor Cut-Out Switch 5 Position 10 Amp 125 V.A.C.
E8332834	Hostlers Control Switch 1 Position 10 Amp. 74 V.D.C,
G41A313736P2	SBM Rotary Switch
G41A313738P1	3 Position Rotary Switch

**Rotary Switch Handles**

<b>PowerRail P/N</b>	<b>Description</b>
E8189077	Switch Handle ¼" O.D. Shaft
E8168346	Screw For Rotary Switch Handle ⅛-40 x 1 1/32
E8168328	Pin For Rotary Switch 3-48 x ½"
E131181	Washer Lock #6

### SWITCHES - ROTARY

Complete Line of Rotary Switches

PowerRail P/N	Description
E8356487	Traction Motor Cut-Out Switch 4 Position 10 Amp 125 V.A.C.
E8435590	Signal Light 2 Position 1 Pole 30A 125V
E8460767	Remote Headlight 3 Position 1 Pole 30A 230V
E9083195	Ac Terminal Light 2 Position 2 Pole 30A 500V
E8298939	Heater 3 Position 2 Pole 30A 230V
E8237656	Directional Headlight 5 Position 2 Pole 30A 230V
E8485569	Slug Control 2 Position 4 Pole 10A 125V
E8437642	Heater 4 Position 4 Pole 30A 74V
E8484926	Heater 4 Position 4 Pole 30A 125V
E8243533	Remote Headlight 4 Position 4 Pole 30A 230V
E6923315	Unit Selector 4 Position 4 Pole 30A 500V
E8439118	Remote Headlight 4 Position 4 Pole 45A 600V
E8422024	Heater 8 Position 5 Pole 30A 230V
E8206315	Isolation 2 Position 6 Pole 30A 500V
E6916566	Isolation 2 Position 8 Pole 30A 500V
E8330988	Isolation 2 Position 8 Pole 30A 500V
E8433191	Isolation 2 Position 9 Pole 45A 600V
E8484096	Isolation 2 Position 10 Pole 45A 600V
E10589900	Rotary Snap 5 Position 2 Pole
G41A314126P1	Motor Cutout Rotary Switch
G84A201850P11	Headlight Rotary Switch



### Rotary Switch Handles

PowerRail P/N	Description
E8193318	Switch Handle 3/8" O.D. Shaft
E132037	Screw For Rotary Switch Handle 10-24 x 7/16"
E8193814	Pin For Rotary Switch 1/8 x 3/4"
E8256115	Washer Lock #10



**TERMINAL BOARDS**

Complete Line Terminal Boards for all Electrical Applications

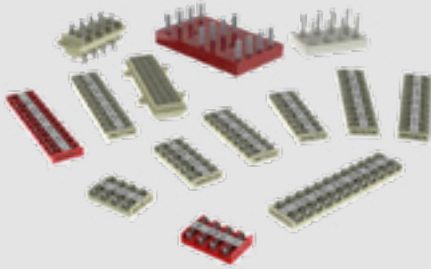

<b>PowerRail P/N</b>	<b>Connection Type</b>	<b>Tabs</b>
E8298162	Fast-On Single Sided	4
E8434754	Fast-On Single Sided	6
E8467946	Fast-On Single Sided	8
E8287076	Fast-On Single Sided	12
E8283970	Fast-On Single Sided	15
E8410147	Fast-On Single Sided	16
E8277744	Fast-On Single Sided	20
E8324824	Fast-On Single Sided	22
E8292938	Fast-On Single Sided	24
E8368473	Fast-On Single Sided	24
E9331353	Fast-On Double Sided	20
E9507683	Bolted Double Sided	8
E8354091	Bolted Single Sided	8
E8422649	Bolted Single Sided	12

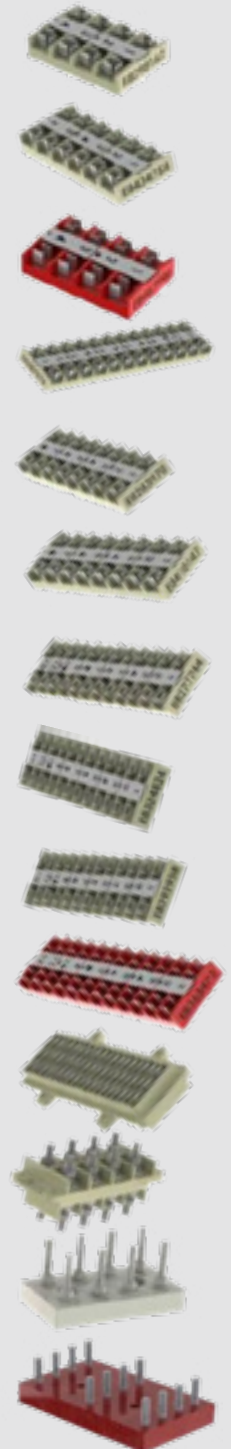

**TOOLS**

Complete Line of Tools

**T50031**

Designed to make the job of torquing crab nuts easier while providing accurate torque results.



**E8171633PRD**

Carrier Snap Ring Enhancement

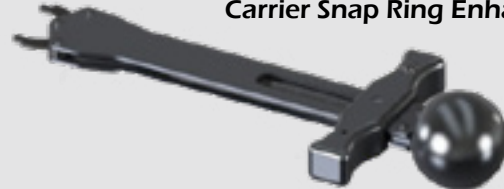

**T57870-115V**

Excellent and uniform torquing of EMD-style power assembly crab nuts. Comes with a 1 1/8" hydraulic powered electric driven power unit rated at 9,000 PSI, a 25' hose assembly, two-wheeled cart, and two socket torques. Wrench head is adjustable from 500 to 3,500 lb. ft. of torque.



**E8239562**

Installer/Remover Bushing



**E8243341**

Hand Tool Breaker Traction Motor Leads



**T54101**

**Crab Nut Tool**

Manual kit for torquing EMD Style crab nuts.

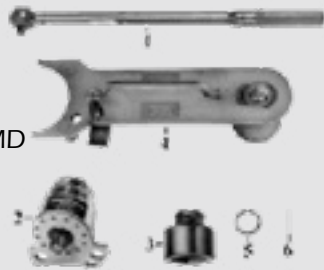

**E8243341PRD**

PRD Enhanced 2-Piece



**T57211 Tool and T57211B for Bolts**

EMD Style Power Assembly Break Loose Jacking Tool



**E87170**

C Frame Tool  
Power Assly Compressor  
Aux. Generators



**E8075894**

Cylinder Head Puller



**8417858**

Lifter Power Assembly



**8432485**

Jack Governor Injector



**E8116358**

Lifter Cylinder Liner



**E8339610**

Rack Setting



\*This is just a sample of the tools we offer.  
Please visit [www.ePowerRail.com](http://www.ePowerRail.com) or call us today for many more.

**TRACTION MOTORS**

Complete Line of Traction Motors, New and Remanufactured.  
We also offer a Full Line of Unit Exchange Combo's

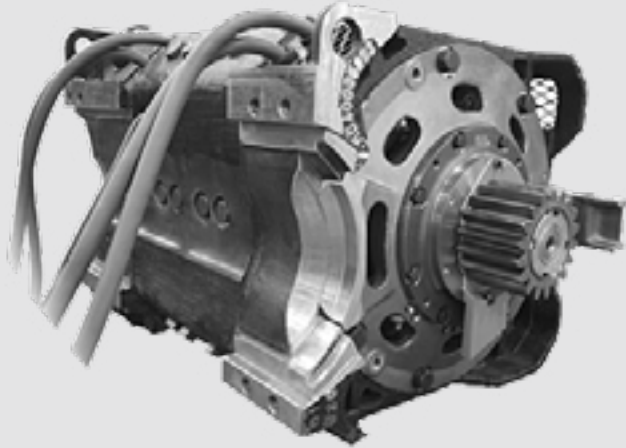

**Short Line & Premium Rebuilds in Stock  
for Immediate Delivery**

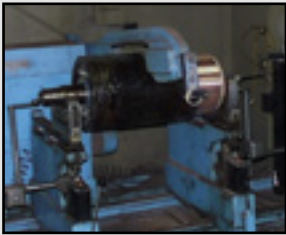
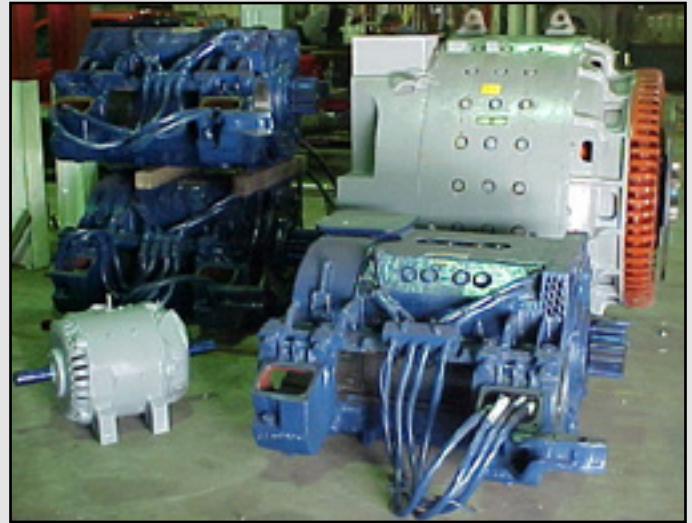

- Class 1 Approved
- Internationally Approved
- Regionals & Short Line Approved
- Quality M-1003 approved Parts
- Quality Workmanship
- Experienced Staff
- Technical Support
- Competitive Price
- Full Line of Support Products

<b>D27/D37/D47</b>	<b>D57/D67</b>	<b>D77/D77B</b>
<b>D78</b>	<b>D87/D87B</b>	<b>D90</b>
<b>752E6</b>	<b>752E8</b>	<b>752 AF</b>
<b>752AG</b>	<b>752AH</b>	<b>GEB</b>

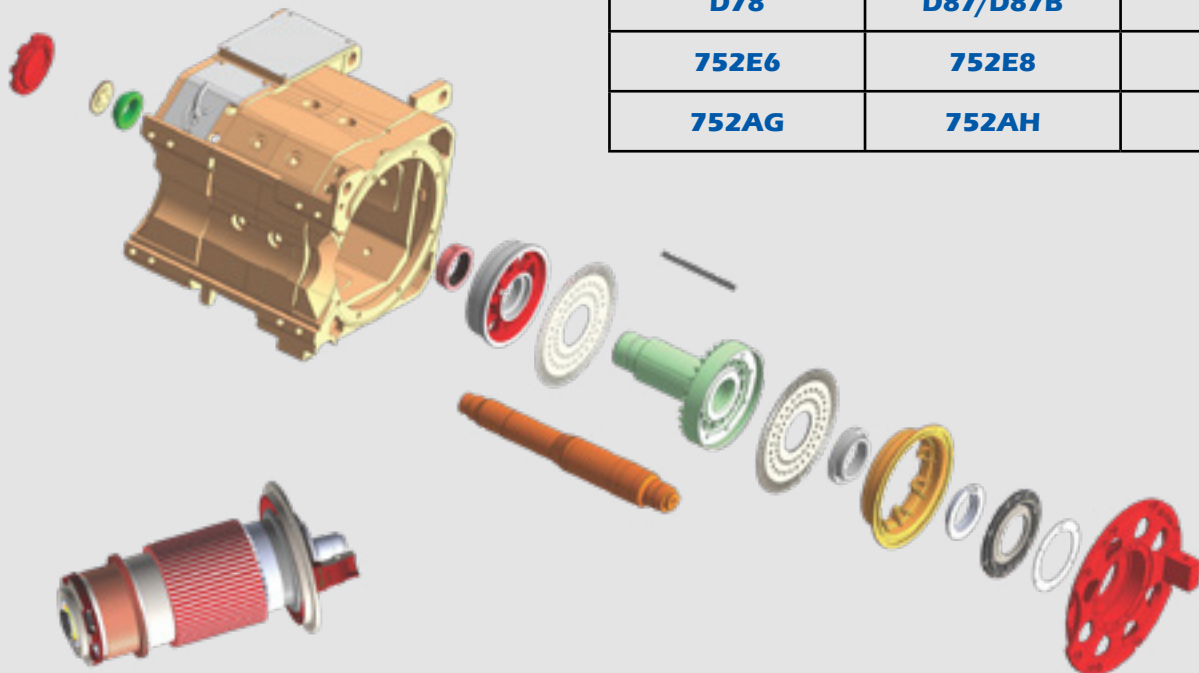

**TRACTION MOTOR CONVERSIONS**

D77 or D87 to D87BTR or D90BTR

Conversion/Upgrades also available in most EMD and GE Models.

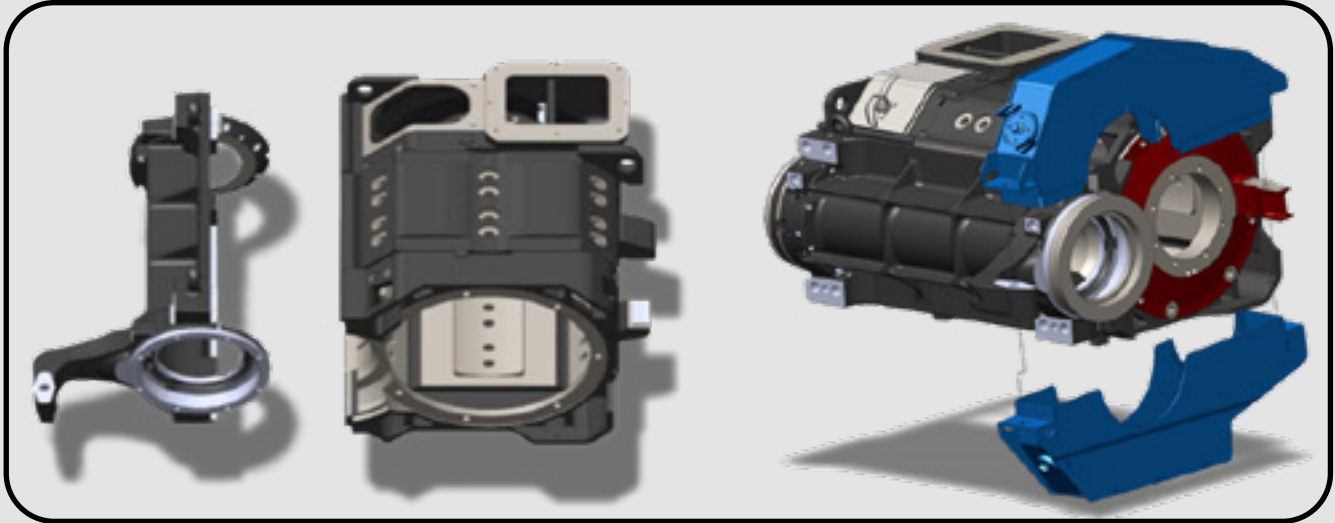

**Narrow**



**Gauge BTR or Axle Cap**

**Standard**



**Gauge BTR or Axle Cap**

**Competitive cost for converting  
Brass Support to BTR U-Tube  
Design using new and/or  
remanufactured components.**



**BENEFITS INCLUDE:**

- ✓ Eliminates brass support bearings and the wick assembly, allowing less maintenance and longer life.
- ✓ Tapered roller support bearings are sealed, eliminating wick lubricators, and the addition of oil.
- ✓ Tapered roller support bearings only require a visual inspection of the seals every 90 days, vs. sleeve-type bearings which require inspection and oil addition every 45 days.
- ✓ Wheelset removal from the traction motor is simplified.
- ✓ Axle wheel gear assembly can be removed from the motor, complete with suspension bearing, and be applied to other motors, as required.

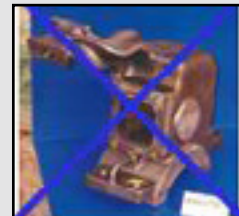

**Eliminate Brass & Wick**



**TRACTION MOTOR CABLES**  
Complete Line of Traction Motor Cables

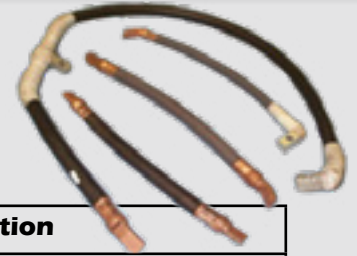

<b>PowerRail P/N</b>	<b>Description</b>	<b>Application</b>
E9565453	Traction Motor Cable	No. 1 to No. 2 - 20 ¾" Long
E9565450	Traction Motor Cable	No. 1 to No. 2 - 21 ¾" Long
E8351147	Traction Motor Cable	No. 1 to No. 4
E8355704	Traction Motor Cable	No. 1 to No. 2
E9319807	Traction Motor Cable	No. 1 to No. 2 and No. 3. to No. 4
E9565451	Traction Motor Cable	No. 3 to No. 4 - 20 ¾" Long
E8355728	Traction Motor Cable	Cable Assembly "A"
E9319806	Traction Motor Cable	Cable Assembly "A"
E9566056	Traction Motor Cable	Cable Assembly "A"
E9566664	Traction Motor Cable	Cable Assembly "A"
E40017962	Traction Motor Cable	Cable Assembly "AA" 87" Long
E8141062	Traction Motor Cable	Lead Assembly "AA" 7' 2½" Long
E9566057	Traction Motor Cable	Cable Assembly "AA" 7' 4¼" Long
E9566661	Traction Motor Cable	Cable Assembly "AA" 7' 4¼" Long
E8141063	Traction Motor Cable	Lead Assembly "F" 6' 10" Long
E40017961	Traction Motor Cable	Cable Assembly "F" 7' ⅝" Long
E9566058	Traction Motor Cable	Cable Assembly "F" 7' ⅝" Long
E9566662	Traction Motor Cable	Cable Assembly "F" - 7' ⅝" Long
E40017963	Traction Motor Cable	Cable Assembly "FF" 76" Long
E8141064	Traction Motor Cable	Lead Assembly "FF" 6' 3" Long
E9566059	Traction Motor Cable	Cable Assembly "FF" - 6' 7 ⅜" Long
E9566663	Traction Motor Cable	Cable Assembly "FF" - 6' 7 ⅜" Long



**New Flexible 3Kv Traction Motor Kit and Cables**

- Easy to Install
- Very Flexible
- Longer Life & Reliable
- Lower cost in Long Run
- 3KV 200 Celsius vs. 2Kv 125 Celsius
- Class 1 approved

### TRACTION MOTOR COVERS

Complete Line of Traction Motor Covers **MODIFIED** with **High Heat** Rubber Gaskets.

PowerRail P/N	Application(s)
E8117405	D7, D17, D27, D37, D47, D57, D67, D75, D77, D87, D90
E8117406	D7, D17, D27, D37, D47, D57, D67, D75, D77, D87, D90
E8176280	D29
E8183868	D7, D17, D27, D37, D57, D67, D75, D77
E8204661	D7, D17, D27, D37, D47, D57, D67, D75, D77, D87
E8204665	D7, D17, D27, D37, D47, D57, D67, D75, D77, D87
E8235994	D29
E8236101	D29
E8300010	D7, D17, D27, D37
E8236103	D29
E8300011	D7, D17, D27, D37, D57, D67, D75, D77
E8300013	D7, D17, D27, D37, D47, D57, D67, D75, D77, D87, D90
E8408599	D57, D67, D75, D77, D87, D90
E8408688	D57, D67, D75, D77



PowerRail P/N	Application(s)
E8467155	D57, D67, D75, D77
E8467156	D57, D67, D75, D77
E9554330	D87, D90
E40007235	D87, D90
E10520631	D90TR
G41C636159G2	752AG, 752AH
G41C636160G2	752AH
G4732425G2	752E8, 752AF
G41C636881G1	752AG
G41D731488G1	752E8, 752AF
G4748663G1	752E8, 752AF
G41C637083G2	752AH
G6726556P1	752E8, 752AF
G9961549G1	752

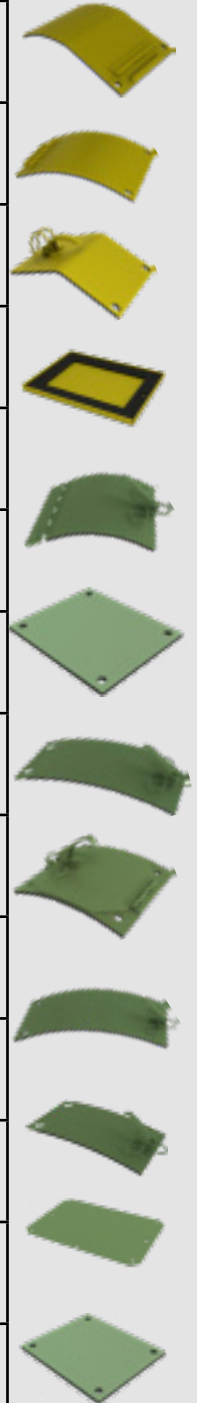

**D77-STYLE TRACTION MOTOR SUPPORT ITEMS**



**Oil Filler Cap**

- Redesigned to stop leaks
- Seal repositioned under head
- Upgraded B-SureSeal™ O-Ring

PowerRail P/N	Description
E9333024	¾" Yellow
E9324109	1" White
G41A238534P1	¾" White

PowerRail P/N	Description
E8104188	Nose Support Plate
E8104189/E9087386	Nose Spring Holder Pack
E8339952	Traction Motor Nose Pack
E8126036	Safety Strap
E8322027	T-Bolt
E8326203	Gear Case Cap - Grease
E8407505	Clamp MS Gear Case
E40051181	Gear Case Install Kit Grease/Oil
E40061419	Gear Case Seal Oil
E40017436	Filler Cap
E8407506	Dust Guard CE

PowerRail P/N	Description
E9333024PRD	¾" Oil Filler Cap - LEAK PROOF
E9324109PRD	1" Oil Filler Cap - LEAK PROOF
E8417729	D77 Brushholder
E9322058	D77 Carbon Brush
E9323317	Seal Ring Oil 8"
E8277771	Wick Lubricator
E9535375	Seal WS
E9535376	Seal MS
E40006705	15T Pinion - See Page 51
E40012790	Pinion Seal



PowerRail P/N	Description
E9583736	D77 Connector Crimp Type 1325/24
E9583737	D77 Connector Crimp Type 1100/24
E9583735	D77 Connector Crimp Type 1480/24

PowerRail P/N	Description
E8341414	EMD Air Duct Assembly
E8350968	TM Sleeve 1.5ID x 14 5/8 L
E8194450	TM Sleeve 1.2ID x 12 1/2 L
E8024365	EMD Switcher Air Duct
E40111584	Cable Cleat D87/D90
E9094306	Cable Cleat D77
E8474056	Cable Cleat
E9087386	Nose Pack Fabricated
E10661110	Insulator Sleeve

PowerRail P/N	Description
E40045238	SD70 - Traction Motor Air Duct
E10664863	SD70 Sleeve Insulating
E9520160	Rubber Faston
E9334248	Traction Nose Pack
E9096902	Sleeve Kit
E8206883	Hi Temp Grommet
G41B532099G1	GE 752 Cable Cleats
E8243341	TM Cable Splitters
E8020225	GP/SD Bogies - Traction Motor Air Duct

## 752-STYLE TRACTION MOTOR SUPPORT ITEMS

### 752E8-Style Traction Motor

PowerRail P/N	Description
G41A238534P1	Oil Fill Cap
G41B535245G1	Seal Ring 9" Oil
G41B537189P1	Dust Seal ME
G41B537190P1	Gutter/Seal WS
G41B537191P1	Gutter/Seal ME
G41B537266P1	Dust Guard CE
G41B537963P1	Brush
G41C632068G1	Wicks Lubricator Only
G41D731488G1	Inspection Cover Bottom
G4748663G1	Inspection Cover Top
G160X1026	Gear Case Install Kit - Grease
41C632667G6	Brushholder - Radial
18T - 20T - 22T	<b>Pinions - See Page 51</b>

### 752AG-Style Traction Motor

PowerRail P/N	Description
G41A238534P1	Oil Fill Cap
G41B535245G1	Seal Ring 9" Oil
G41C636752P1	Gutter
G41C636752P1	Gutter
G41B537963P1	Brush
G41D711633P	GE 752AG Air Duct
G41C635696G1	Wicks Lubricators Assy Complete
G41C636159G23	Inspection Cover Bottom
G41C636160G2	Inspection Cover Bottom
G41C636881G1	Inspection Cover Top
G160X1067	Gear Case Install Kit - Oil
G41C632667G6	Brushholder - Radial
18T - 20T - 22T	<b>Pinions - See Page 51</b>

### 752AF-Style Traction Motor

PowerRail P/N	Description
G41A238534P1	Oil Fill Cap
G41B535245G1	Seal Ring 9" Oil
G41B535795G1	Spring Cap - Grease
G41B535882P2	Dust Seal Motor
G41B535883P2	Gutter Motor Side
G41B535885P2	Gutter Wheel Side
G41B537266P1	Dust Guard CE
G41B537307P1	Flinger Ring CE
G41B537466P1	Lip Seal - Gear Case
G41B538243P1	Filler Cap
G41C635696G1	Wicks Lubricator Assy
G41C637106P1	Seal ME
G41A235215P3	Clamp Dust Guard
G41D731488G1	Inspection Cover Bottom
G4748663G1	Inspection Cover Top
G752AF-Set	Gear Case Install Kit - Grease
G41C632667G	Brushholder Radial
G41C633771G2	Brushholder - Reaction
18T - 20T - 22T	<b>Pinions - See Page 51</b>
G160X1067	Gear Case Install Kit - Oil

## SUPPORT BEARINGS - TRACTION MOTOR BRASS

Complete Line of Premium Brass Support Bearings



PowerRail P/N	Description
E9557789	8" Standard
E9557790	8" 1/32" U.S.
E9557791	8" 1/16" U.S.
E9557792	8" 3/32" U.S.
E9557793	8" 1/8" U.S.
E9557794	8" Std. 1/32" OS Flange
E9557797	8 1/4" Standard
E9557798	8 1/4" 1/32" U.S.
E9557799	8 1/4" 1/16" U.S.
E9557800	8 1/4" 3/32" U.S.
E9557801	8 1/4" 1/8" U.S.
G41B535757G6	9" Standard
G41B535757G7	9" 1/32" U.S.
G41B535757G8	9" 1/16" U.S.
G41B535757G9	9" 1/8" U.S.
G41B535757G10	9" 3/16" U.S.

## TERMINAL LUGS

Complete Line of Terminal Lugs

### 2-Hole Terminal Lugs

PowerRail P/N	Description
G41A201820P1	3 3/4" OD, 1 1/32" Bolt, 925/24 Cable
G8868241AAP1	2 15/16" OD, 5/16" Bolt, 113/27 Cable
G8868241AAP2	2 5/8" OD, 5/16" Bolt, 113/24 Cable
G8868241AAP14	3 3/16" OD, 5/16" Bolt, 550/24 Cable
G8868241AAP16	3 3/16" OD, 5/16" Bolt, 775/24 Cable
G8868241AAP17	3 3/4" OD, 3/8" Bolt, 925/24 Cable
G8868241AAP18	3 3/4" OD, 3/8" Bolt, 1100/24 Cable

### Battery Terminal Lugs

PowerRail P/N	Description
E8197509	0.880" ID, 13/32" Stud Hole, 4/0 Cable
E8211044	0.806" ID, 13/32" Hole, Flat Tongue 3/0 Wire
E8183110	0.880" ID, 13/32" Stud Hole, 4/0 Cable

### Butt Connector Terminal Lugs

PowerRail P/N	Description
E8188705	0.984" ID, 4.625" L, 1325/24
E8188706	1.100" ID x 1.340" x 4.62" L, 1600/24
E8188707	0.984" ID x 4.62" L, 1100/24

### Glad Hand Terminal Lugs

PowerRail P/N	Description
E8109922	0.938" ID, 775/24, 1100/24 Solder
E8160270	1.000" ID, 5.312 L, 1325/24 Solder
E8137331	1.1875" ID, 5.312 L, 1600/24 Solder
E9583737	.938" ID, 5.312 L, 1100/24 Crimp
E9583736	.984" ID, 5.312 L, 1325/24 Crimp
E9583735	1.030" ID, 5.312 L, 1480/24 Crimp
E40028834	1.094" ID, 5.55 L, 1600/24 Crimp

### Insulated Crimp Terminal Lugs with Stud Hole

PowerRail P/N	Description
E8123282	0.250" ID, 1/4" Stud Hole, Yellow, 12-18AWG
E8189218	0.170" ID, #6 Stud Hole, Blue, 14-18AWG
E8210498	0.170 ID, #10 Stud Hole, Blue, 14-18AWG
E8198189	0.170" ID, 1/4" Stud Hole, Blue, 14-18AWG
E8123281	0.170" ID, #10 Stud Hole, Yellow, 12-18AWG
E8123283	0.250" ID, 5/16" Stud Hole, Yellow, 12-18AWG
E8123284	0.250" ID, 3/8" Stud Hole, Yellow, 12-18AWG

### Non-Insulated Crimp Terminal Lugs with Stud Hole

PowerRail P/N	Description
G41A265615P10	#8 or 10 Stud, 10-22 AWG
E10634854	Yellow, #10 Stud, Tongue 12-14 AWG
E8131368	0.284 ID, 3/8" Stud Hole, 4 AWG
E8269635	0.120" ID, #10 Stud Hole, 16-22 AWG
E8281475	0.180" ID, #10 Stud Hole, 14-18 AWG
E8282623	0.180" ID, 1/4" Stud Hole, 14-18 AWG
E8292367	0.192" ID, 1/4" Stud Hole, 10-14 AWG
E8292368	0.192" ID, #8/10 Stud Hole, 10-12 AWG
E8301545	0.192" ID, 3/8" Stud Hole, 10-14 AWG
E9098813	0.393" ID, 5/16" Stud Hole, 225/24 AWG

### Non-Insulated Crimp Terminal Lugs without Stud Hole

PowerRail P/N	Description
E8118060	0.650 ID, No Stud Hole, 550/24 AWG
E8118061	0.762" ID, No Stud Hole, 775/24 AWG
E8118062	0.895" ID, No Stud Hole, 1100/24 AWG
E8160274	0.984" ID, No Stud Hole, 1325/24 AWG
E8352379	1.100" ID, No Stud Hole, 1600/24 AWG



## U TUBES

Complete Line of U Tube Housings

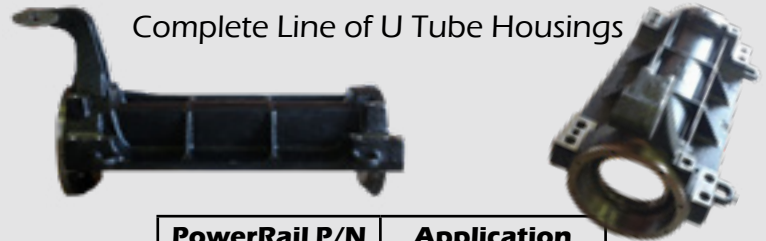

PowerRail P/N	Application
E40006120	D87
E40006950	B87BTR
E40035256	D90BTR
E40045090	SD70AC
E40053326	SD90

GE-Style U Tubes available upon request

### **BOGIE ASSEMBLIES**

**PowerRail Locomotive Services**, a division of PowerRail, located in Monroe, GA, offers repair, rebuild, and remanufacturing services for the following EMD bogie types to customer specifications or PLS scope.

Unit Exchange of bogies also available. We do International Bogies, as well. Please call for details.



#### **GP CLASP - EMD BLOMBERG**

Hyatt or Timken GG Bearings  
Clasp Brake Arrangement

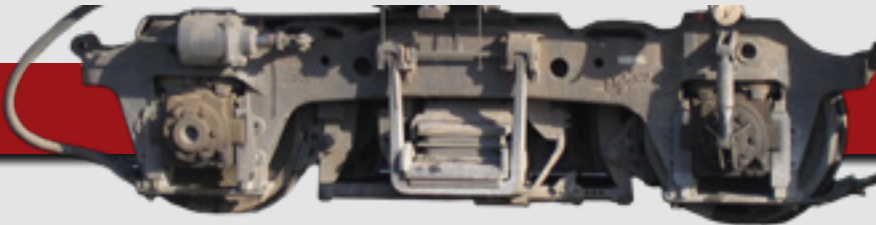

#### **GP SINGLE SHOE - EMD BLOMBERG**

Hyatt or Timken GG Bearings  
OEM Single Shoe Brake Arrangement

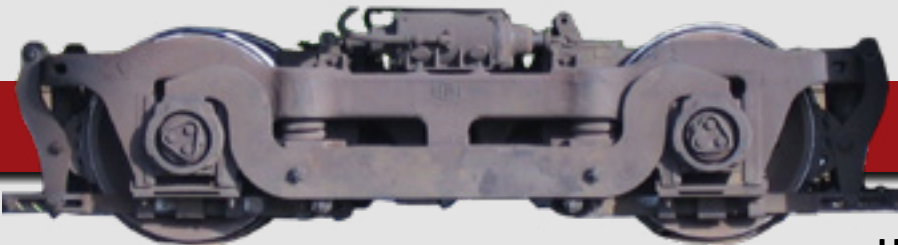

#### **EMD SWITCHER BOGIE**

Friction or Roller Bearing  
Universal (AAR/Rigid) or Flexible Bogies

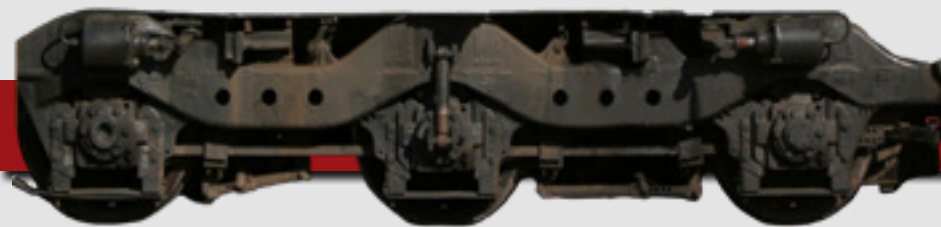

#### **EMD SD HTC or FLEXICOIL BOGIES**

Hyatt or Timken GG Bearings

Additional options include:

- GP Clasp to Single Shoe Conversion and Associated Modification Kit
- Traction Motor / Wheel Set Combo Rebuilding
- GE Bogie overhauls and rebuilds

## BOGIE PARTS

### When it comes to Bogie Parts, why PowerRail?

- PowerRail is the only company in the US that manufactures all of our brake rigging and bogie parts in-house AND provides bogie overhauls at our own PowerRail Locomotive Services.
- PowerRail is the only company in the US that can provide OEM equivalent (or ENHANCED) bogie parts with steel bushings OR with thermoplastic bushings, which are proven to provide extended life through 20+ years of in-the-field testing.
- Our experience with bogie kits and brake rigging applications is second to none. From manufacturing the parts, to completing the overhauls in-house, our expertise and application knowledge is above all the rest.
- We offer a full line of GE-style and EMD-style bogie parts, components, and brake rigging, as well as customer friendly bogie kits, packaged to your liking and built to your specifications.

### BRAKE PRODUCTS

Complete Line of Brake Head, Keys, Pins & Bushings for Locomotive Bogies.

PowerRail P/N	Description	Comment
E8151703	Brake Head	OE Style
E8160059	Brake Head	GP OE
E8160060	Brake Head	OE Style
E8235906	Brake Head	OE Style
E8242785	Brake Head	SW Bogies
E8385297	Brake Head	OE or Canted Style
E8388332	Brake Head	OE or Canted Style
G41A210602P2	Brake Shoe Key	13"
E8101930	Brake Shoe Key	14"
E9501303	Brake Shoe Key	15"
E8100136	Brake Shoe Key	16"
E8101977	Brake Shoe Key	20"

Many others available upon request



### TuffRigg™ BRAKE RIGGING

PowerRail's manufactured full line of EMD-style and GE-style **TuffRigg™** brake rigging utilizes thermoplastic bushings as a superior alternative to steel. PowerRail's enhanced design, coupled with our exclusive distribution of A153/S thermoplastic bushings, has years of proven success. These bushings are confirmed to prevent brake head seizures and provide enhanced wear properties that will extend the life of your brake rigging.

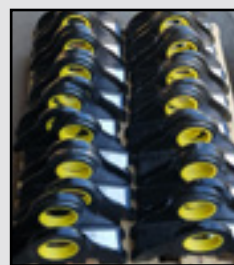

Benefits of **TuffRigg™** Brake Rigging with A153/S Thermoplastic Bushings:

- Reduction in seizures and housing reclamation
- No alignment difficulties when assembling
- Proven reduced maintenance costs
- A153/S bushings are resistant to shock loading & corrosion
- Reduction in wear resulting in increased performance by up to 5x's when compared to steel
- A153/S bushings have a low coefficient of friction, high compressive strength, and consistent wear characteristics

## BOGIE PARTS - CENTER PLATES, BOWL LINERS & PEDESTAL LINERS

Complete Line of Steel, Manganese and Special  
Molded Wear Parts for All Locomotives



PowerRail P/N	Description
E9548794	Center Bowl Liner Style 2 axle rigid bogie Assy (3/8" Thick)
E9562813	Wear Bowl Liner Style 2 axle rigid bogie Assy (1/2" Thick)
E9085368	Wear Bowl Liner 3/8" Bottom Plate Nylatron 17 7/8" Dia.
E9085369	Center Bowl Liner Style Flexicoil bogie Assy SD Series
E8068060	GP Bogies - Wear Plate
E8492124	Center Bowl Liner Style 3 axle bogie Assy SD-2, SD50/60
G41C629423G1	Center Bowl Liner Fits GE Style 3 Axle "C" Bogies
G41C629424G1	Center Bowl Liner Fits GE Style 2 Axle "B" Bogies
E9329633	Center Wear Plate - GP Bogies - 1/2 Ring
E8048966	SW Bogies - Inner Ring
E8025096	SW Bogies - Outer Ring

PowerRail P/N	Description
E9324108 E4001004 E40012413	EMD-style Pedestal Liner
G41B515390P1 G41B515390P3	GE-style Pedestal Liner
E8206915	4" x 3" x 1/4" Nylon Plate
E8206916	5" x 2.625" x 1/4" Plate
E8386454	5.25" x 2.75" x 1/4" Plate
E8088354	10" x 3" x 1/4" Plate
E8336782-3/8	3/8" Thick
E8336782-3/4	3/4" Thick
E40010820	SW/GP/SD Bogies - Pedestal Liner Kit with Fastener



## BOGIE PARTS - COIL AND ELLIPTICAL LEAF SPRINGS

Complete Line of Coil Springs and Leaf Springs

PowerRail P/N	Application
E9549172	Double Coil
E8228050	Double SD40
E8057051	Spring Outer
E8057052	Inner Middle
E8057053	Spring Inner
E8106539	Elliptical Leaf Spring Set of 4

PowerRail P/N	Application
E8229325	Elliptical Leaf Spring
E8354463	Elliptical Spring Assembly Set
E9568083	GP Bogies - Elliptic Spring Nest Assembly (Low Profile)
E9085317	GP Bogies - Double Coil Journal Spring Assembly
E8024365	SW Bogies - Traction Motor Air Duct
E40020765	GP/SD Bogies - Journal Spring Pad

\*Common Stock Items





**BOGIE PARTS - GEAR CASE SETS**

Complete Line of D77/D78/D87 Grease & Oil Gear Case Sets and Install Kits

**Part #: PRD16185978 - Gear Case Set Oil Filled COMPLETE**

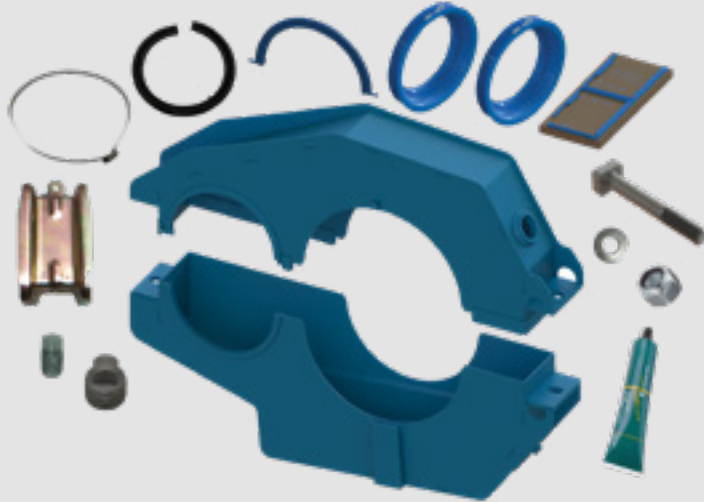

PowerRail P/N	Description	Qty
E40021647PLOK	Gear Case Oil Filled Lower	1
E40024857PLOK	Gear Case Oil Filled Upper	1
<b>PRD16184978TOIL / T-Bolt Oil Kit</b>		
E103410	Cotter Pin	2
E103880	Pipe Plug	1
E103881	Pipe Plug	1
E108659	Cotter Pin	2
E40012790	Seal Pinion Rubber	2
E40061419PRD	Seal Assembly Kit Oil Gear Case	1
E8126036	Safety Strap Gear Case	2
E8322027	T Bolt	2
E8366747	Compound Sealant Clear	1
E8407505	Clamp Wheelside Gutter	2
E8407506	Seal Dust Guard Commutator End	1
E9535375PRD	Ring Seal Outer Gear Case	1
E9535376PRD	Ring Seal Inner Gear Case	1
E8032750	Locknut Nylock	2
PRD16184773	Washer Flat	2

**COMPLETE GEAR CASE AND SEAL KIT \*OIL FILLED**

**Part #: PRD16185977 - Gear Case Set Grease Filled COMPLETE**



PowerRail P/N	Description	Qty
E9540306PLOK	Gear Case Grease Filled Lower	1
E9540598PLOK	Gear Case Grease Filled Upper	1
<b>PRD16184978TGRS / T-Bolt Grease Kit</b>		
E103410	Cotter Pin	2
E108659	Cotter Pin	2
E40012790	Seal Pinion Rubber	2
E40017436PRD	Cap Filler Gear Case	1
E40061419PRD	Seal Assembly Kit Oil Gear Case	1
E8126036	Safety Strap Gear Case	2
E8322027	T Bolt	2
E8366747	Compound Sealant Clear	1
E8407505	Clamp Wheelside Gutter	2
E8407506	Seal Dust Guard Commutator End	1
E9535375PRD	Ring Seal Outer Gear Case	1
E9535376PRD	Ring Seal Inner Gear Case	1
E8032750	Locknut Nylock	2
PRD16184773	Washer Flat	2

**COMPLETE GEAR CASE AND SEAL KIT \*GREASE FILLED**

**BOGIE PARTS - GEAR CASE SETS (cont.)**

**Part #: PRD16186701T - Gear Case Set Oil Filled T-Bolt COMPLETE**



PowerRail P/N	Description	Qty
E40017364PLOK	Gear Case Oil Filled Lower - D87BTR	1
E40017363PLOK	Gear Case Oil Filled Upper - D87BTR	1
<b>PRD16184978TBTR / T-Bolt Oil Kit</b>		
E103410	Cotter Pin	1
E108659	Cotter Pin	2
E40006689	Seal Inner Ring	1
E40012790	Seal Pinion Rubber	2
E40017436PRD	Cap Gear Case Filler	2
E40061419PRD	Seal Assembly Kit Oil Gear Case	1
E8126036	Safety Strap Gear Case	2
E8322027	T Bolt	2
E8366747	Compound Sealant Clear	1
E8407505	Clamp Wheelside Gutter	2
E8407506PRD	Seal Dust Guard Commutator End	1
E9535375PRD	Ring Seal Outer Gear Case	1
E8032750	Locknut Nylock	2
E8322026	Washer Flat	2
PRD16184773	Washer Flat	2

**COMPLETE GEAR CASE AND SEAL KIT \*OIL FILLED**

**Part #: PRD16186701H - Gear Case Set Oil Filled Huck Bolt COMPLETE**



PowerRail P/N	Description	Qty
E40017364PLOK	Gear Case Grease Filled Lower	1
E40017363PLOK	Gear Case Grease Filled Upper	1
<b>PRD16186701 / Huck Bolt Oil Kit</b>		
E103410	Pin Cotter	1
E108659	Pin Cotter	2
E40006689	Seal Inner Ring	1
E40012790	Seal Pinion Rubber	2
E40017436PRD	Cap Gear Case Filler	2
E40061419PRD	Seal Assembly Kit Oil Gear Case	1
E8126036	Safety Strap Gear Case	2
E8423699	Rivet Huck	2
E8366747	Compound Sealant Clear	1
E8407505	Clamp Wheelside Gutter	2
E8407506PRD	Seal Dust Guard Commutator End	1
E9535375PRD	Ring Seal Outer Gear Case	1
E40034493	Huck Collar	2
E8322026	Washer Flat	2

**COMPLETE GEAR CASE AND SEAL KIT \*OIL FILLED**

**BOGIE PARTS - GEAR CASE INSTALLATION KITS**



**PRD16184978HUCK / Huck Bolt Oil Kit**

PowerRail P/N	Description	Qty
E103880	Pipe Plug	1
E103881	Pipe Plug	1
E40012790	Seal Pinion Rubber	2
E40034493	Huck Collar	2
E40061419PRD	Seal Assembly Kit Oil Gear Case	1
E8126036	Safety Strap Gear Case	2
E8366747	Compound Sealant Clear	1
E8407505	Clamp Wheelside Gutter	2
E8407506	Seal Dust Guard Commutator End	1
E842369	Rivet Huck	2
E9535375PRD	Ring Seal Outer Gear Case	1
E9535376PRD	Ring Seal Inner Gear Case	1
PRD16184773	Washer Flat	2

PowerRail P/N	Description	Qty
E103410	Cotter Pin	2
E103880	Pipe Plug	1
E103881	Pipe Plug	1
E108659	Cotter Pin	2
E40012790	Seal Pinion Rubber	2
E40061419PRD	Seal Assembly Kit Oil Gear Case	1
E8126036	Safety Strap Gear Case	2
E8322027	T Bolt	2
E8366747	Compound Sealant Clear	1
E8407505	Clamp Wheelside Gutter	2
E8407506	Seal Dust Guard Commutator End	1
E9535375PRD	Ring Seal Outer Gear Case	1
E9535376PRD	Ring Seal Inner Gear Case	1
E8032750	Locknut Nylock	2
PRD16184773	Washer Flat	2



**PRD16184978TOIL / T-Bolt Oil Kit**



**PRD16184978TGRS / T-Bolt Grease Kit**

PowerRail P/N	Description	Qty
E103410	Cotter Pin	2
E108659	Cotter Pin	2
E40012790	Seal Pinion Rubber	2
E40017436PRD	Cap Filler Gear Case	1
E40061419PRD	Seal Assembly Kit Oil Gear Case	1
E8126036	Safety Strap Gear Case	2
E8322027	T Bolt	2
E8366747	Compound Sealant Clear	1
E8407505	Clamp Wheelside Gutter	2
E8407506	Seal Dust Guard Commutator End	1
E9535375PRD	Ring Seal Outer Gear Case	1
E9535376PRD	Ring Seal Inner Gear Case	1
E8032750	Locknut Nylock	2
PRD16184773	Washer Flat	2

**BOGIE PARTS - GEAR CASE INSTALLATION KITS (cont.)**

PowerRail P/N	Description	Qty
E103410	Cotter Pin	2
E108659	Cotter Pin	2
E40017436PRD	Cap Filler Gear Case	1
E8126036	Safety Strap Gear Case	2
E8257840	Seal Kit Felt	2
E8322027	T Bolt	2
E8366747	Compound Sealant Clear	1
E8407505	Clamp Wheelside Gutter	1
E8407506PRD	Seal Dust Guard Commutator End	1
E8032750	Locknut Nylock	2
E8322026	Washer Flat	2
E8310818	Seal Rope Gear Case	1



**PRD16184978TFELT / T-Bolt Grease Felt Seal Kit**



**PRD16184978TBTR / T-Bolt D87 Kit**

PowerRail P/N	Description	Qty
E103410	Pin Cotter	1
E108659	Pin Cotter	2
E40006689	Seal Inner Ring	1
E40012790	Seal Pinion Rubber	2
E40017436PRD	Cap Gear Case Filler	2
E40061419PRD	Seal Assembly Kit Oil Gear Case	1
E8126036	Safety Strap Gear Case	2
E8322027	T Bolt for Safety Strap	2
E8366747	Compound Sealant Clear	1
E8407505	Clamp Wheelside Gutter	2
E8407506PRD	Seal Dust Guard Commutator End	1
E9535375PRD	Ring Seal Outer Gear Case	1
E8032750	Locknut Nylock	2
E8322026	Washer Flat	2

PowerRail P/N	Description	Qty
E103410	Pin Cotter	1
E108659	Pin Cotter	2
E40006689	Seal Inner Ring	1
E40012790	Seal Pinion Rubber	2
E40017436PRD	Cap Gear Case Filler	2
E40061419PRD	Seal Assembly Kit Oil Gear Case	1
E8126036	Safety Strap Gear Case	2
E8423699	Rivet Huck	2
E8366747	Compound Sealant Clear	1
E8407505	Clamp Wheelside Gutter	2
E8407506PRD	Seal Dust Guard Commutator End	1
E9535375PRD	Ring Seal Outer Gear Case	1
E40034493	Huck Collar	2
E8322026	Washer Flat	2



**PRD16184978HBTR / Huck Bolt D87 Kit**

**BOGIE PARTS - EMD-STYLE GEAR CASES**

<b>PowerRail P/N</b>	<b>DESCRIPTION</b>	<b>TM</b>	<b>SEALS</b>	<b>RATIO</b>	<b>LOCOMOTIVES</b>	<b>LUBE</b>
E9540306PLOCK	Lower Gear Case	D77/87	Plastic	62:15	DD, F, F7A, F7B, FP, GP, SD, SDP, SW, NR11	Grease
<b>E9540306COMBO</b>	<b>Lower Gear Case</b>	<b>D77/87</b>	<b>Plastic</b>	<b>62:15</b>	<b>DD, F, F7A, F7B, FP, GP, SD, SDP, SW, NR11</b>	<b>Grease or Oil</b>
E9540307PLOCK	Lower Gear Case	D77/87	Plastic	62:15	DD, F, F7A, F7B, FP, GP, SD, SDP, SW, NR11	Grease
<b>E9540307COMBO</b>	<b>Lower Gear Case</b>	<b>D77/87</b>	<b>Plastic</b>	<b>62:15</b>	<b>DD, F, F7A, F7B, FP, GP, SD, SDP, SW, NR11</b>	<b>Grease or Oil</b>
E9540598PLOCK	Upper Gear Case	D77/87	Plastic	62:15	DD, F, F7A, F7B, FP, GP, SD, SDP, SW, NR11	Grease
<b>E9540598COMBO</b>	<b>Upper Gear Case</b>	<b>D77/87</b>	<b>Plastic</b>	<b>62:15</b>	<b>DD, F, F7A, F7B, FP, GP, SD, SDP, SW, NR11</b>	<b>Grease or Oil</b>
E40021647PLOCK	Lower Gear Case	D77/87	Plastic	62:15	DD, F, F7A, F7B, FP, GP, SD, SDP, SW, NR11	Oil
<b>E40021647COMBO</b>	<b>Lower Gear Case</b>	<b>D77/87</b>	<b>Plastic</b>	<b>62:15</b>	<b>DD, F, F7A, F7B, FP, GP, SD, SDP, SW, NR11</b>	<b>Grease or Oil</b>
E40024857PLOCK	Upper Gear Case	D77/87	Plastic	62:15	DD, F, F7A, F7B, FP, GP, SD, SDP, SW, NR11	Oil
<b>E40024857COMBO</b>	<b>Upper Gear Case</b>	<b>D77/87</b>	<b>Plastic</b>	<b>62:15</b>	<b>DD, F, F7A, F7B, FP, GP, SD, SDP, SW, NR11</b>	<b>Grease or Oil</b>
E8301948PLOCK	Upper Gear Case	D77/87	Felt	62:15	DD, F, F7A, F7B, FP, GP, SD, SDP, SW, NR11	Grease
<b>E8301948COMBO</b>	<b>Upper Gear Case</b>	<b>D77/87</b>	<b>Felt</b>	<b>62:15</b>	<b>DD, F, F7A, F7B, FP, GP, SD, SDP, SW, NR11</b>	<b>Grease or Oil</b>
E9315720PLOCK	Lower Gear Case	D77/87	Felt	62:15	DD, F, F7A, F7B, FP, GP, SD, SDP, SW, NR11	Grease
<b>E9315720COMBO</b>	<b>Lower Gear Case</b>	<b>D77/87</b>	<b>Felt</b>	<b>62:15</b>	<b>DD, F, F7A, F7B, FP, GP, SD, SDP, SW, NR11</b>	<b>Grease or Oil</b>
E9310002PLOCK	Lower Gear Case	D77/87	Plastic	62:15	DD, F, F7A, F7B, FP, GP, SD, SDP, SW, NR11	Grease
<b>E9310002COMBO</b>	<b>Lower Gear Case</b>	<b>D77/87</b>	<b>Plastic</b>	<b>62:15</b>	<b>DD, F, F7A, F7B, FP, GP, SD, SDP, SW, NR11</b>	<b>Grease or Oil</b>
E40038097PLOCK	Lower Gear Case	D70	Plastic	83:18	SD70, SD751, SD80MAC, SD90AC, SD90MAC	Oil
<b>E40038097COMBO</b>	<b>Lower Gear Case</b>	<b>D70</b>	<b>Plastic</b>	<b>83:18</b>	<b>SD70, SD751, SD80MAC, SD90AC, SD90MAC</b>	<b>Grease or Oil</b>
E4003808PLOCK	Upper Gear Case	D70	Plastic	83:18	SD70, SD751, SD80MAC, SD90AC, SD90MAC	Oil
<b>E40038098COMBO</b>	<b>Upper Gear Case</b>	<b>D70</b>	<b>Plastic</b>	<b>83:18</b>	<b>SD70, SD751, SD80MAC, SD90AC, SD90MAC</b>	<b>Grease or Oil</b>
E40046866PLOCK	Lower Gear Case	D90/100	Plastic	83:18	SD70, SD751, SD80MAC, SD90AC, SD90MAC	Oil
<b>E40046866COMBO</b>	<b>Lower Gear Case</b>	<b>D90/100</b>	<b>Plastic</b>	<b>83:18</b>	<b>SD70, SD751, SD80MAC, SD90AC, SD90MAC</b>	<b>Grease or Oil</b>
E40046865PLOCK	Upper Gear Case	D90/100	Plastic	83:18	SD70, SD751, SD80MAC, SD90AC, SD90MAC	Oil
<b>E40046865COMBO</b>	<b>Upper Gear Case</b>	<b>D90/100</b>	<b>Plastic</b>	<b>83:18</b>	<b>SD70, SD751, SD80MAC, SD90AC, SD90MAC</b>	<b>Grease or Oil</b>
E40017363PLOCK	Upper Gear Case	D87BTR	Plastic	70:17	GP60, SD60I	Oil
<b>E40017363COMBO</b>	<b>Upper Gear Case</b>	<b>D87BTR</b>	<b>Plastic</b>	<b>70:17</b>	<b>GP60, SD60I</b>	<b>Grease or Oil</b>
E40017364PLOCK	Lower Gear Case	D87BTR	Plastic	70:17	GP60, SD60I	Oil
<b>E40017364COMBO</b>	<b>Lower Gear Case</b>	<b>D87BTR</b>	<b>Plastic</b>	<b>70:17</b>	<b>GP60, SD60I</b>	<b>Grease or Oil</b>
E9540579PLOCK	Upper Gear Case	E Motor	Plastic	65:12	DD, F, FP, GP, DP, SW	Grease

**BOGIE PARTS - EMD-STYLE GEAR CASES (cont.)**

PowerRail P/N	DESCRIPTION	TM	SEALS	RATIO	LOCOMOTIVES	LUBE	
<b>E9540579COMBO</b>	<b>Upper Gear Case</b>	<b>E Motor</b>	<b>Plastic</b>	<b>65:12</b>	<b>DD, F, FP, GP, DP, SW</b>	<b>Grease or Oil</b>	
E9541129PLOCK	Lower Gear Case	E Motor	Plastic	65:12	DD, F, FP, GP, DP, SW	Grease	
<b>E9541129COMBO</b>	<b>Lower Gear Case</b>	<b>E Motor</b>	<b>Plastic</b>	<b>65:12</b>	<b>DD, F, FP, GP, DP, SW</b>	<b>Grease or Oil</b>	
E8301947PLOCK	Upper Gear Case	E Motor	Felt	65:12	DD, F, FP, GP, DP, SW	Grease	
<b>E8301947COMBO</b>	<b>Upper Gear Case</b>	<b>E Motor</b>	<b>Felt</b>	<b>65:12</b>	<b>DD, F, FP, GP, DP, SW</b>	<b>Grease or Oil</b>	
E8302646PLOCK	Lower Gear Case	E Motor	Felt	65:12	DD, F, FP, GP, DP, SW	Grease	
<b>E8302646COMBO</b>	<b>Lower Gear Case</b>	<b>E Motor</b>	<b>Felt</b>	<b>65:12</b>	<b>DD, F, FP, GP, DP, SW</b>	<b>Grease or Oil</b>	
E8429098PLOCK	Upper Gear Case	D29/43	Felt	71:18	REPLACES 8283441	Grease	
<b>E8429098COMBO</b>	<b>Upper Gear Case</b>	<b>D29/43</b>	<b>Felt</b>	<b>71:18</b>	<b>REPLACES 8283441</b>	<b>Grease or Oil</b>	
E8283442PLOCK	Lower Gear Case	D29/43	Felt	71:18		Grease	
<b>E8283442COMBO</b>	<b>Lower Gear Case</b>	<b>D29/43</b>	<b>Felt</b>	<b>71:18</b>		<b>Grease or Oil</b>	
E9557134PLOCK	Upper Gear Case	D29/D44	Plastic	Narrow 71:18		Grease	
<b>E9557134COMBO</b>	<b>Upper Gear Case</b>	<b>D29/D44</b>	<b>Plastic</b>	<b>Narrow 71:18</b>		<b>Grease or Oil</b>	
E9559650PLOCK	Lower Gear Case	D29/D43	Plastic	Narrow 71:18		Grease	
<b>E9559650COMBO</b>	<b>Lower Gear Case</b>	<b>D29/D43</b>	<b>Plastic</b>	<b>Narrow 71:18</b>		<b>Grease or Oil</b>	
E8344966PLOCK	Upper Gear Case	D29CC	Felt	Narrow	G18, GL22	Grease	
<b>E8344966COMBO</b>	<b>Upper Gear Case</b>	<b>D29CC</b>	<b>Felt</b>	<b>Narrow</b>		<b>Grease or Oil</b>	
E8344965PLOCK	Lower Gear Case	D29CC	Felt	Narrow	GT22, G26, GT26	Grease	
<b>E8344965COMBO</b>	<b>Lower Gear Case</b>	<b>D29CC</b>	<b>Felt</b>	<b>Narrow</b>		<b>Grease or Oil</b>	
E40105121PLOCK	Upper Gear Case	70ACE	Plastic			Oil	
<b>E40105121COMBO</b>	<b>Upper Gear Case</b>	<b>70ACE</b>	<b>Plastic</b>			<b>Grease or Oil</b>	
E4015120PLOCK	Lower Gear Case	70ACE	Plastic			Oil	
<b>E4015120COMBO</b>	<b>Lower Gear Case</b>	<b>70ACE</b>	<b>Plastic</b>			<b>Grease or Oil</b>	
E40017436PRD	Gear Case Cap	<b>ENHANCED PLASTIC CAP FOR GREASE STYLE GEAR CASES</b>					

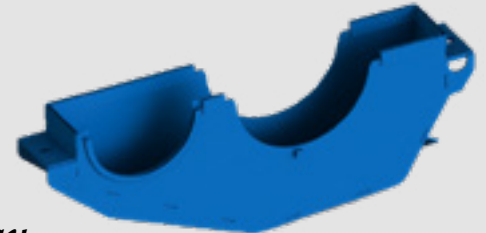
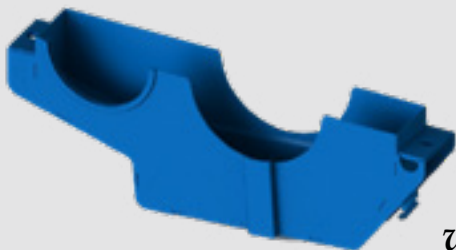

**BOGIE PARTS - GE-STYLE GEAR CASES**

PowerRail P/N	DESCRIPTION	TM	RATIO	LOCOMOTIVES	LUBE
G41D731910G2 G46756697G2	Upper Gear Case	E8	74:18	B23 -7, M630, U18B, U23B, U25C, U25B, U30B, U30C, U33C, U36C, C -424	Grease
<b>G41D731910G8 G6756697G3</b>	<b>Lower Gear Case</b>	<b>E8</b>	<b>74:18</b>	<b>B23 -7, M630, U18B, U23B, U25C, U25B, U30B, U30C, U33C, U36C, C -424</b>	<b>Grease</b>
G41D731910G7 or G9 G6756697G1 or G11	Set Gear Case	E8	74:18	B23 -7, M630, U18B, U23B, U25C, U25B, U30B, U30C, U33C, U36C, C -424	Grease
<b>G41D732358P1 G41D732364G2</b>	<b>Upper Gear Case</b>	<b>AF</b>	<b>83:20</b>	<b>C30 -7, C30 -7A, C36 -7, C39 -8, C40 -8, C40 -8M, C40 -8, C40 -9, DASH 8 -32B</b>	<b>Grease</b>
G41D732358P1 G41D732364G3	Lower Gear Case	AF	83:20	C30 -7, C30 -7A, C36 -7, C39 -8, C40 -8, C40 -8M, C40 -8, C40 -9, DASH 8 -32B	Grease
<b>G41D732364G1</b>	<b>Set Gear Case</b>	<b>AF</b>	<b>83:20</b>	<b>C30 -7, C30 -7A, C36 -7, C39 -8, C40 -8, C40 -8M, C40 -8, C40 -9, DASH 8 -32B</b>	<b>Grease</b>
G41D735356P1 G41D735347P2	Upper Gear Case	AG	83:20	C40 -8 (Reminder: An AG will fit an AF)	Oil
<b>G41D735868P1</b>	<b>Lower Gear Case</b>	<b>AG</b>	<b>83:20</b>	<b>C40 -8 (Reminder: An AG will fit an AF)</b>	<b>Oil</b>
G41D735359G3 or G41D735668G1	Set Gear Case	AG	83:20	C40 -8 (Reminder: An AG will fit an AF)	Oil
<b>G41D735347P2</b>	<b>Upper Gear Case</b>	<b>AH</b>	<b>83:20</b>	<b>C40 -CW, GE DASH 9'S</b>	<b>Oil</b>
G41D735340P6 G41D735797P1	Lower Gear Case	AH	83:20	C40 -CW, GE DASH 9'S	Oil
<b>G41D735315G3</b>	<b>Set Gear Case</b>	<b>AH</b>	<b>83:20</b>	<b>C40 -CW, GE DASH 9'S</b>	<b>Oil</b>
G41D730230G1 or G3 G970X21 G41D732863G3	Set Gear Case	761	Narrow GAGE	Set's Only 1 1/2" - 6 thread w/ caps  Sets Only 1" - 8 thread w/ caps	Grease
<b>G41D735642P1</b>	<b>Lower Gear Case Amtrak</b>	<b>AH</b>	<b>83:20</b>	<b>P40 - P42</b>	<b>Oil</b>
G41D735644P1	Upper Gear Case Amtrak	AH	83:20	P40 - P42	OIL
<b>G41D735428G1</b>	<b>Upper Gear Case</b>	<b>761</b>	<b>Narrow GAGE</b>	<b>A22, 23, or 24</b>	<b>Grease</b>
G41D735428G2	Lower Gear Case	761	Narrow GAGE	A22, 23, or 24	Grease
<b>G41D736089G3</b>	<b>Upper Gear Case</b>	<b>C44</b>			<b>Oil</b>
G41D736091G1	Lower Gear Case	C44			Oil
<b>G41D7366091G5</b>	<b>Lower Gear Case</b>	<b>C44</b>		<b>SUPERSEDED BY 41D7366091G6</b>	<b>Oil</b>
G41B538243P1 G41AA230409G3	Gear Case Cap	<b>BASE MADE WITH GALVANIZED STEEL WITH RUBBER SEAL</b>			

### BOGIE PARTS - GEAR CASE SEALS

Complete Line of Gear Case Seals, Wicks Lubricators, Caps and Dust Guards



### BOGIE PARTS - LEVERS, HANGERS & BRAKE RELATED PARTS

Complete Line of Components for Locomotive Bogies

PowerRail P/N	Application
E9500246	Brake
E9500247	Brake
E8160062	Brake
E9098135	Brake
E8044914	Brake
E8044915	Brake
E8107338	Brake
E8107339	Brake
E8044911	Brake
E8157951	Brake Hanger
E8099416	Connection Strap, OE or Modified 42" Wheel
E8465284	Connection Strap, OE or Modified 42" Wheel
E40034696	Cylinder
E40034694	Cylinder
E40035166	Cylinder
E40035154	Cylinder



PowerRail P/N	Application
E40033871	Guide
E8441548	Guide
E40033873	Guide
E8466631	Guide
E8157951	Hanger
E8389488	Hanger Inside
E8044912	Hanger Inside
E8441551	Hanger Inside
E8401941	Hanger Outside
E8044911	Hanger Outside
E8475110	Hanger Outside
E8160062	Inside Yoke Brake
E8334026	Outside Yoke Brake
E8334027	Outside Yoke Brake
E8044913	Strap
E8228267	Strap
E8228266	Strap



## BOGIE KITS

PowerRail offers custom Bogie Kits, made in the USA to customer specifications. Available parts include high/low profile elliptic springs, bushings, pins, levers, hangers, and more. All Bogie Kits are available with Thermoplastic or Steel bushings. Some examples include, but are not limited to:

PowerRail P/N	Description	Application
PRD16185821	Bogie Kit	GP Clasp, Basic
PRD16184195	Bogie Conversion Kit	GP Blomberg, Clasp to Single Shoe Conversion Kit
PRD16187088	Bogie Overhaul Kit	EMD Switcher, Flexible Bogie
PRD16186640	Bogie Overhaul Kit	GP Blomberg Single Shoe, Converted from Clasp
PRD16186666	Bogie Kit	Universal, AAR Rigid Switcher
PRD16186679	Bogie Overhaul Kit	SD Flexicoil, Single Shoe
PRD16186792	Bogie Kit, Pins & Bushings	EMD Switcher, Flexible Bogie
PRD16186796	Bogie Overhaul Kit	SD HTC, Single Shoe, GG Bearings w/ Oil Filled Gear Cases
PRD16186797	Bogie Overhaul Kit	SD HTC, Single Shoe, GG Bearings w/ Grease Filled Gear Cases
PRD16186802	Bogie Overhaul Kit	GP Blomberg, Clasp Brakes
PRD16186826	Bogie Overhaul Kit	GP OEM SS (GP50), Converted from clasp with brake head stabilization and low profile elliptic springs
PRD16186827	Bogie Kit	GP Blomberg, Clasp to Single Shoe Overhaul & Conversion Kit
PRD16186924PB	Bogie Kit	GP Blomberg, Clasp to Single Shoe Conversion and Overhaul Kit with Thermoplastic Bushings and light duty springs
PRD16187166	Bogie Overhaul Kit	SD HTC, Single Shoe
PRD16187438	Bogie Kit	SD HTC, Single Shoe
PRD16186776	Bogie Kit	GE 3 Axle, Basic
PRD16186777	Bogie Overhaul Kit	GE 3 Axle, Overhaul

### Sample Kit

PRD16184195

GP Blomberg, Clasp to Single Shoe Conversion Kit



### Sample Kit

PRD16186777

GE 3 Axle, Overhaul



**BOGIE PARTS - SLACK ADJUSTERS**

Complete Line of Locomotive Slack Adjusters and Brake Rigging

PowerRail P/N	Application
E9334230	SW Style
E9334229	GP Style Clasp Brake
E40042095	GP Style
E40039040	SD Style
E40039041	SD Style
G41C619252G1	GE
G41C612181G1	GE
G41C614411G2	GE



PowerRail P/N	Application
E8465284	Connection Strap, OE or Mod. 42" Wheels
E8099416	Connection Strap, OE or Mod. 42" Wheels
E8044913	Switcher - 2 or 3 Hole Strap
E9527279	GP Bogies, Single Shoe Brakes
E9516057	Slack Adjuster Assembly, Long
E9513003	Slack Adjuster Assembly, Short

**BOGIE PARTS - SWING HANGERS**

Complete Line of Unit Exchange or NEW Swing Hangers and related parts.

PowerRail P/N	Description
E8044697	GP Bogie - Upper Swing Hanger Bearing Block
E8044698	GP Bogie - Lower Swing Hanger Bearing Block
E8068056	Bushing 2.250" x 2.754" x 1.375"
E8102087	Bushing 2.250" x 2.750" x 2.250"
E8309537	Bushing 2.250" x 2.758" x 2.250"
E8309538	Bushing 2.250" x 2.780" x 2.250"
E8309539	Bushing 2.250" x 2.800" x 2.250"
E8078796	Pin Drilled Both Ends 1 1/2" x 10"

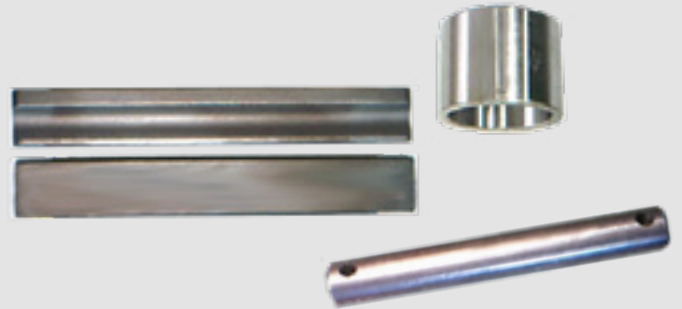

This represents a brief summary of our most commonly sold Bogie parts and components. For a full listing of all bogie-related items, please download our Bogie Parts Catalogue.

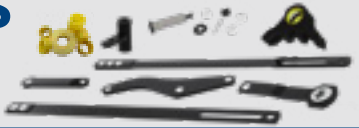

Scan **HERE**  to download our **NEW** Bogie Parts Catalogue

**TREADS, HANDRAILS AND RAILING**

Complete Line of FRA Approved Treads, Grab Irons, Steps and Handrails

**\*Below is a Sampling of Parts**

PowerRail P/N	Description
E9092557	Support Handrail 23.50"
E8258472	Support Handrail 36.75"
E8361180	Support Handrail 36.75"
E8368491	Support Handrail 41.75"
E8379948	Support Handrail 41.75"
E8379949	Support Handrail 41.75"
E8379953	Support Handrail 41.75"
E9553636	Support Handrail 41.75"
E8313482	Support Handrail 43.75"
E8331857	Support Handrail 43.75"
E8355621	Support Handrail 43.75"
E8216378	Support Handrail 45.75"
E8304234	Support Handrail 45.75"
E8344827	Support Handrail 49.375"
E8379950	Support Handrail 51.375"
E8379951	Support Handrail 51.375"
E8389882	Support Handrail 52.75"
E8313798	Support Handrail 53.375"
E8331849	Support Handrail 54.75"
E8315142	Support Handrail 56.75"
E8379947	Support Handrail 56.75"

PowerRail P/N	Description	Application
E9315313	Tread	GP38
E8342231	Tread	GP38/SD40
E8342230	Tread	GP38/SD40
E9319219	Tread	SD40
E9319220	Tread	SD40
E9315311	Tread	GP38
G41C629248P1	Tread	Dash 7
G41A242229P2	Tread	Dash 7
PRD16184535	Wide Tread	SD40-2

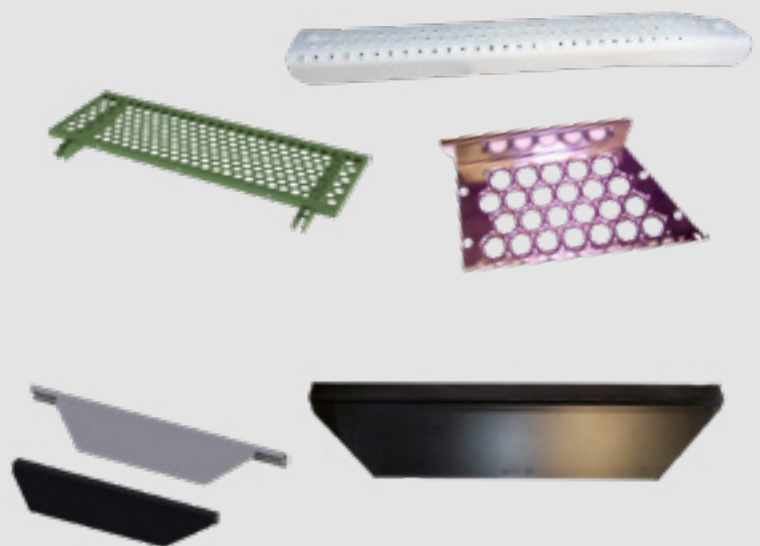

E8123974 Awning 55" Long SD60 SD70

E9334250 Awning 55 5/8" Long SD60 SD70

Note: We also Carry Safety Chain  
#E8189774 and Breakaway Link 60212

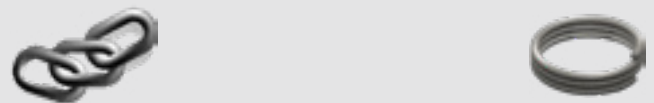

### TURBOCHARGER

Complete Line of New and Unit Exchange Turbochargers, as well as related components including Spring Drive Gears, Clutch Assemblies, and Turbo Screens

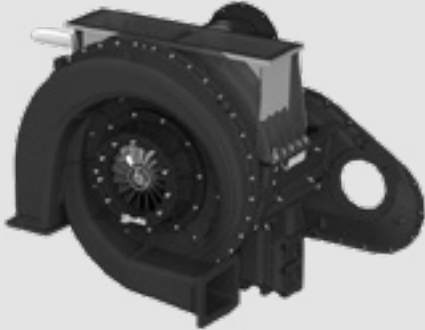

- **Class 1 Approved**
- **Quality Parts**
- **Quality Workmanship**
- **Experienced Staff**
- **Technical Support**
- **Competitive Pricing**
- **Full Line of Support Products**



PowerRail P/N	Description
E8296440 E8333500	16cyl 567D3
E8358500 E8368596	16cyl 645E3
E8410283 E8413707	12cyl 645E3
E9338194 E9525597 E40057108 E9339283	16cyl 645E3B
E9511706 E9524135	12cyl 645E3B

PowerRail P/N	Description
E9543498	16cyl 645F3B
E9568355 E40111762	16cyl 710G3
E40108869 E40031530	16cyl 710G3A/B
E40053534 E40108870 E40110641	16cyl 710G3C
G126X1869	Dash 9 Special Upgraded EFI
G126X1842	12cyl GE1412
G126X1691 G126X1716 G126X1819	16cyl 7S1616

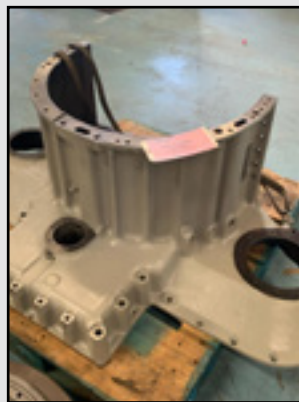

E9502409  
Eductor Tube Outer  
E9502412  
Eductor Tube Inner



E40089234  
Heat Shield



E9557143 and E40155024  
High Heat Turbo Screen  
New or UX  
Starburst Design



After-cooler Ducts  
New or Unit Exchange

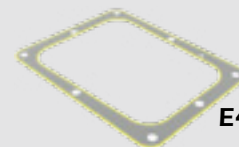

E40034637 Air Duct  
to Turbo Gasket



**WHEELSETS AND COMBOS**

Complete Line of New & Unit Exchange Axles, Wheels, Wheelsets and Combos



Full Line Of New and Remanufactured Axles and Wheels



Full Line Of New and Remanufactured Wheelsets Hyatt and GG Styles



Full Line Of New and Remanufactured U-Tube Style Wheelsets and Traction Motor Combos

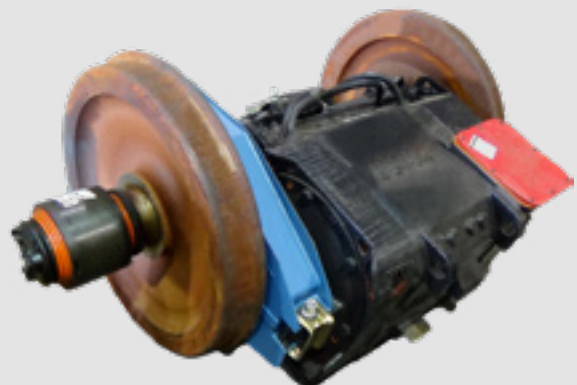

### WIPER MOTORS & BLADES

Complete Line of Air Operated Motors, Arms and Blades

**\*New and Unit Exchange**



PowerRail P/N	Description	Comment
E9088065	Wiper Arm	11"
E8138424	Wiper Arm	12"
E40078283	Wiper Arm	SD70 18"
G84B100880P4	Wiper Arm	18"
G84B513412P	Wiper Arm	18"
E9319906	Wiper Arm	20"
E8148136	Wiper Arm	21"
E40056292	Wiper Arm - Heavy Duty	SD70 13 1/2"
E40056293	Wiper Arm - Heavy Duty	SD70 16"
C-1100-11	Wiper Blade	11"
E8351298	Wiper Blade	12"
E8151270	Wiper Blade	13"
E8037312	Wiper Blade	14"
E8128733	Wiper Blade	15"

PowerRail P/N	Description	Comment
C-1100-17	Wiper Blade	17"
C-1100-18	Wiper Blade	18"
E8407810	Wiper Blade	20"
E10591173	Wiper Hose	8"
E10581390	Wiper Hose	28"
E8155981	Wiper Hose Assy	20 1/4"
E8227244	Wiper Motor	100° Sweep
E8369430	Wiper Motor	50°, 3 3/4" Shaft
E8479945	Wiper Motor	30° Sweep
E8371406	Wiper Motor	50°
E8371408	Wiper Motor	70°
E9506600	Wiper Motor	90° Sweep
E9506601	Wiper Motor - Door	50° Sweep
E9506606	Wiper Motor Cover	—
E8136957	Wiper Motor Repair Kit	40°, 60°, 70°, 80°
E8295087	Wiper Valve	T-Knob
E9316239	Wiper Valve	7/8" Hex

